

NEW VRF SYSTEMS RANGE 2018 — 2019

**ENERGY SAVING, EASY  
INSTALLATION AND  
HIGH EFFICIENCY**



# PANASONIC INDUSTRIAL VRF SYSTEMS



Professional solutions for all types of projects.

The new Panasonic VRF system is specifically designed for energy saving, easy installation and high efficiency performance, with a wide choice of outdoor and indoor unit models and unique features which are designed for the most demanding offices and big buildings.



# VRF HIGHLIGHTED FEATURES



## Panasonic provides an extensive range of solutions for mid and large buildings. Combining the best option to satisfy all needs and site restrictions.

The unique manufacturer that can combine both Electrical VRF and Gas powered VRF in same project, delivering best choice that makes the difference to our customers.

Providing large choice in indoor units, can connect also water heat exchangers, air handling unit and ventilation units with or without heat exchanger. All managed from simple and powerful stand alone remote control, new centralised controls or cloud connection with 3G embedded. Controls that can be managed remotely by a simple.

The cutting edge control technology is called VRF Smart Connectivity, combining the expertise of VRF communication and BEMS leading company to maximise comfort, and efficiency while reducing installation and integration costs.

	ECOi. Electrical VRF			ECO G. Gas Powered VRF	
	2-Pipe Mini ECOi	2-Pipe ECOi EX	3-Pipe ECOi 6N	2-Pipe ECO G GE3	3-Pipe ECO G GF3
Capacity range	4-10HP	8-80HP	8-48HP	16-60HP	16-25HP
Extreme temperatures operation	-20°C	-25°C	-20°C	-21°C	-21°C
Number of indoor units	15	64	52	64	24
Simultaneity ratio	50 ~ 130%	200%	150%	—	50 ~ 200%
Indoor units	All (check restrictions)				
Controls	All				
Other ranges integration	PACi full control integration + Domestic integration by accessory				

### Energy saving



The Inverter range provides greater efficiency, more comfort, more precise temperature control, without highs and lows, and keeps the ambient temperature constant with lower energy consumption and a significant reduction in noise and vibration levels.



Multiple large-capacity all inverter compressors (more than 14HP). Two independently controlled inverter compressors achieve high efficiency. Redesigned components in the body provide performance improvement especially in the rated cooling condition and EER performance.



Intelligent Human Activity Sensor and new Sunlight Sensor technologies that can detect and reduce waste by optimising air conditioner operation according to room conditions. With just one touch of a button, you can save energy.



ECO G technology offers the best in energy efficiency. ECO G gas VRF is specially designed for buildings where the electricity is restricted or CO<sub>2</sub> emissions must be reduced.



High efficiency models performs higher COP than standard units and standard combinations.

### High performance



The ECOi EX system works in heating mode with performance data at outdoor temperature down to -25°C.

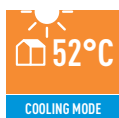

The ECOi EX system works in cooling mode with performance data at outdoor temperature up to 52°C.

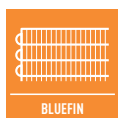

Panasonic has extended the life of its condensers with an original anti-rust coating.



Self-diagnosing function. By using electronic control valves past warnings are stored. This makes it easier to diagnose malfunctions, reducing service labour and therefore costs.



Automatic fan operation. Convenient microprocessor control automatically adjusts fan speed to High, Medium or Low, corresponding to room sensor and maintains comfortable airflow throughout the room.



By intermittent control of compressor and indoor unit's fan, "Mild Dry" gives you comfort. It realizes efficient dehumidification according to room temperature.



Comfortable auto-flap control. When the unit is first turned on, flap position is automatically adjusted in accordance with the cooling or heating operation.



Automatic restart function for power failure. Even when power failure occurs, preset programmed operation can be reactivated once power is resumed.



Air Sweep. The air sweep function moves the flap up and down in the air outlet, directing air in a "sweeping" motion around the room and providing comfort in every corner.



Built-in drain pump. Maximum head 50cm (or 75cm for U type) from the bottom of the unit.



The Panasonic renewal system allows good quality existing R22 pipe work to be re-used whilst installing new high efficiency R410A systems.



5 Years Warranty. We guarantee the outdoor unit compressors for five years.

### High connectivity



The new AC Smart Cloud from Panasonic allows you to have complete control of all your installations. In a simple click, all your units from several locations, receive status updates in real-time of all your installations, preventing breakdowns and optimizing costs.



Internet Control is a next generation system providing a user-friendly remote control of air conditioning or heat pump units from everywhere, using a simple Android or iOS smartphone, tablet or PC via internet.

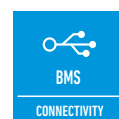

The communication port is integrated into the indoor unit and provides easy connection to, and control of, your Panasonic heat pump to your home or building management system.

# PANASONIC IS DEFINITELY THE MOST EFFICIENT SYSTEM THROUGHOUT THE YEARS



And highly adapted to retail, hotels and offices applications

Outstanding efficiency at part load conditions:

Comparison with competitors: When many others do not declare performance data under 50% part load, Panasonic covers up to 30% part load with extremely high efficiency.

COP comparison Panasonic vs other competitors at different load

Load %	110%	100%	60%	50%	40%	30%
Other competitors	3,52	3,38	3,45	3,50		
Panasonic VRF 6N Series 32HP Standard	3,38	3,41	4,41	4,69	4,85	4,93
Panasonic VRF 6N Series 32HP HI COP	3,91	3,94	5,14	5,54	6,03	6,51

Conditions: Outdoor temperature 0°C DB, Room temperature 20°C DB.

COP (W/W)

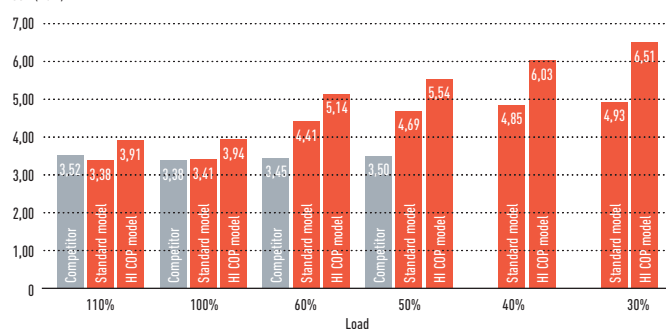

\* Data extracted by Panasonic and competitor official technical data book.

Excellent SEER and SCOP values for VRF 2 and 3-Pipe

Panasonic have a extremely high SEER and SCOP values following seasonal space cooling/heating energy efficiency by COMMISSION REGULATION (EU) 2016/2281.

	SEER	SCOP
<b>Mini ECOi</b>		
U-4LE2E5 / U-4LE2E8	7,85	4,87
U-5LE2E5 / U-5LE2E8	7,48	4,40
U-6LE2E5 / U-6LE2E8	7,25	4,24
U-8LE1E8	6,27	4,24
U-10LE1E8	6,37	4,31
<b>2-Pipe</b>		
U-8ME2E8	7,43	4,79
U-10ME2E8	6,83	4,26
U-12ME2E8	6,65	4,72
U-14ME2E8	7,23	4,28
U-16ME2E8	6,43	4,05
U-18ME2E8	7,56	4,29
U-20ME2E8	7,03	4,09
<b>3-Pipe</b>		
U-8MF2E8	6,08	4,16
U-10MF2E8	5,32	3,72
U-12MF2E8	5,32	3,87
U-14MF2E8	5,43	3,89
U-16MF2E8	5,46	3,68

ESEER calculation corresponds with below conditions and the input power of indoor units is not included.

- Indoor temperature: 27°C DB / 19°C WB
- Outdoor temperature conditions

Part load ratio	25%	50%	75%	100%
Outdoor air temperature (°C DB)	20	25	30	35
Weighting coefficients	0,23	0,41	0,33	0,03

· Formula : 0,23 x EER25% + 0,41 x EER50% + 0,33 x EER75% + 0,03 x EER100%.

Efficient defrost operation

Panasonic use the second unit to defrost the first unit. This makes the system more efficient during defrost and does not affect comfort.

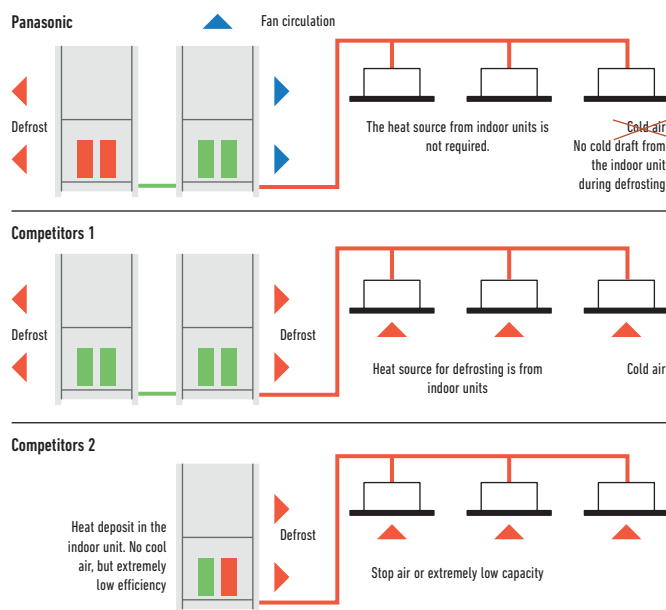

Panasonic ECOi operates at as low as -25°C

This unique feature demonstrate the supremacy of Panasonic ECOi 6N Series.

Panasonic use the second unit to defrost the first unit. This makes the system more efficient during defrost and does not affect the comfort.

Wide temperature setting range

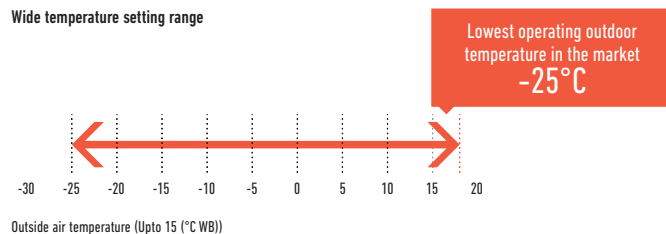

# PANASONIC VRF TOP COMFORT





As a standard, from 2006 all Panasonic VRF systems include the special VET technology, with variable coolant temperature.

### Variable Evaporation and Condensation Temperature

The "smart logic" checks the temperature every 30 seconds and automatically adjusts the coolant temperature according to real demand and outdoor conditions, ensuring better energy performance at all times.

### Temperature varies from 16 °C to 3 °C.

Similarly, the condensation temperature is also variable and is adjusted to the room thermal load, within a range of 33–55 °C.

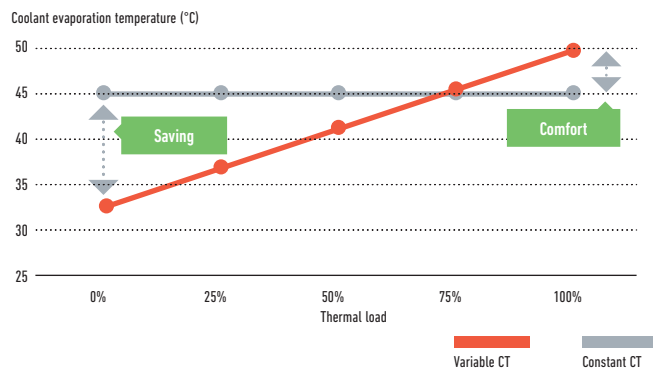
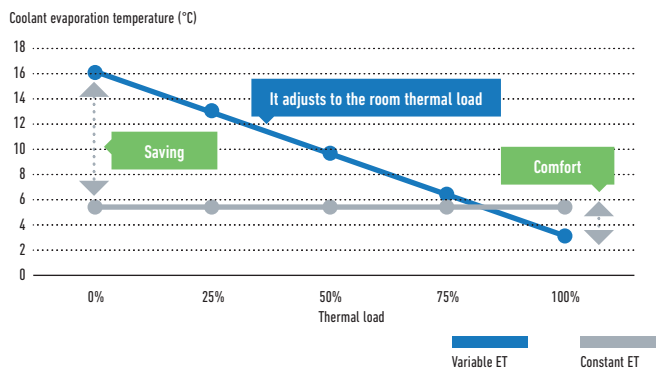

Example of cooling mode (heating mode is also available)

**Indoor environment with a low thermal load**  
The evaporation temperature is kept at a high temperature  
Maximum energy saving

**Higher thermal load**  
The evaporation temperature lowers, adjusting itself to the thermal load  
Maximum comfort

**Maximum thermal load**  
The evaporation temperature lowers further  
Maximum performance

### Technical focus Variable temperatures

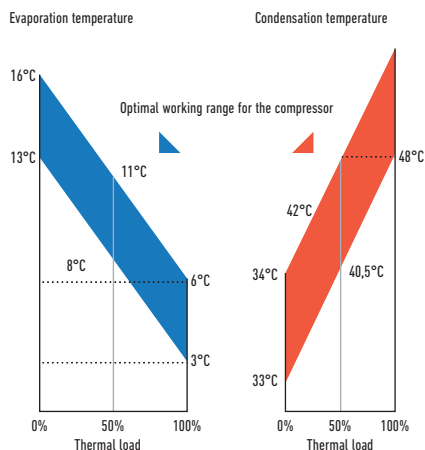

### Control of the discharge temperature

This special function is available in all of Panasonic VRF systems' indoor units to guarantee maximum comfort for the end user. For example, in cooling mode, if the temperature of the discharged air was below 10 °C, the user may feel discomfort, just as he would do in heating mode if the temperature was far too high. With the Panasonic control of the discharge air temperature, this can be adjusted within a cooling range of 7–22 °C.

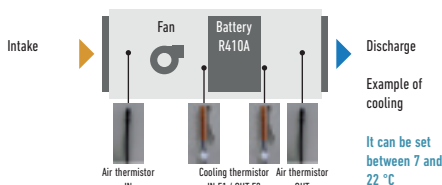

### Benefits

- The air will never be too cold or too warm
- Cooling and Heating function
- Comfort
- Energy saving
- It prevents the formation of condensation within ducts and vents, improving levels of hygiene.

# SOLUTIONS FOR RESTAURANTS

## Full heating, cooling and DHW solutions for Restaurants

### High efficient at part load conditions.

Panasonic has solutions for optimising the installation of cooling, heating and DHW production. While the kitchen needs cooling, heating is needed for DHW and also for heating the public area, with the advantage of 100% fresh air that removes odours. Combining smartly all these needs with Panasonic technology, result in a simple and flexible system adaptable to any restaurant requests, with lower utility bills. Additionally, Panasonic is the unique offering solution for areas where electric power is limited, using ECO G, VRF units powered mainly by Natural Gas or Propane, bringing comfort and DHW anywhere.



#### 1 ECOi (Electric VRF).

ECOi electrical VRF is specifically designed for the most demanding hotels. High efficiency system. Extended operating range to provide heating at outdoor temperature as low as -25°C. Suitable for refurbishment projects.

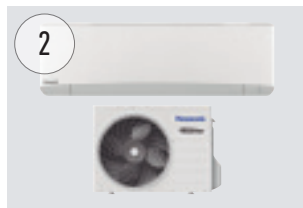

#### 2 PKEA outdoor unit for server room.

Steady cooling, nonstop, even at -20°C and still with high efficiency. Ready for continuous operation and easy to connect 2 systems to automatically alternate and ensure server rooms are kept cool.

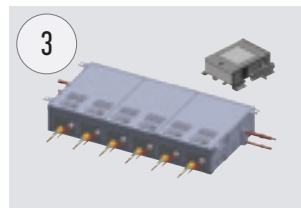

#### 3 3-Pipe control box kit.

New Heat Recovery box to connect multiple indoor units with just one box, 4, 6 and up to 8 indoor units or groups. This is good advantage specially in hotels applications, where space for connecting several boxes is limited.



#### 4 Aquarea T-CAP.

Ideal for heating, cooling and for production of big quantities of hot water at 65°C, Aquarea have an extremely quick return on investment and a low CO<sub>2</sub> footprint.



#### 5 Control your way.

Wide variety of controls, from simple user control to full system control via remote access functionality. Touch panel, web server, consumption control, smartphone control... everything is possible.

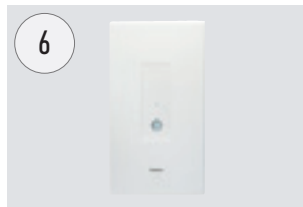

#### 6 Hydrokit for ECOi. Water at 45°C.

Produces LT hot water it is compatible with both ECOi, heat pump and heat recovery outdoors.

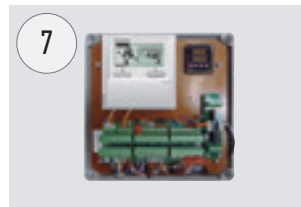

#### 7 Air Handling Unit kits for efficient ventilation.

The new AHU kit is specially designed to improve the efficiency of the pre-heating or pre-cooling process of the ventilation.



#### 8 Hide Away, for power and efficiency.

Super silent units deliver the ideal air supply. Units available from 1,5kW providing precise temperature control even in small rooms. Two models available: slim unit for height restricted areas (MM unit only 200mm deep), another which allows 100% fresh air (MF).



#### 9 Wall Mounted.

The K2 Type wall mounted unit has a stylish smooth panel which not only looks good but is also easy to clean. The unit is also smaller, lighter and substantially quieter than previous models making it ideal for small offices and other commercial applications.



#### 10 Air Curtain with DX Coil.

The Panasonic range of air curtains is designed for smooth operation and efficient performance.

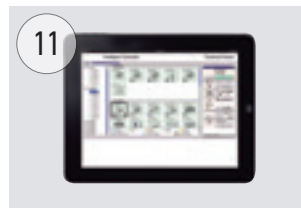

#### 11 Protocol friendly.

Great flexibility for integration into your KNX / Modbus / LonWorks / BACnet projects allows fully bi-directional monitoring and control of all the functioning parameters. Range of solutions to control locally or remotely the full system in bi-directional mode.



#### 12 Panasonic AC Smart Cloud.

Taking your business under control. New service function makes maintenance works simpler.

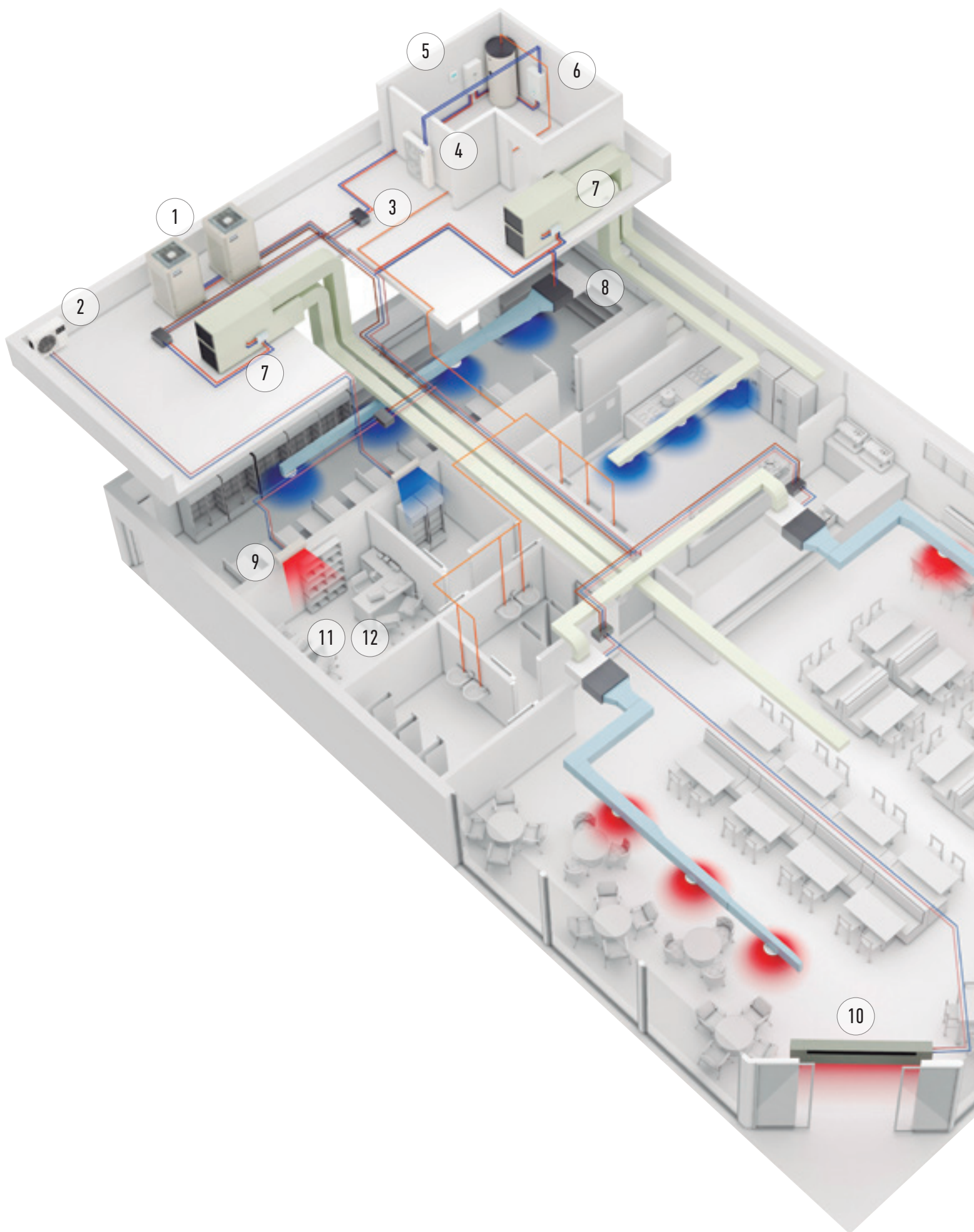

# YOUR ENTIRE HOTEL WITH SUPERIOR SAVINGS, CONTROL AND COMFORT



**Hybrid system.**  
Gas + Electricity Hybrid system. Taking advantage of Gas and Electricity to achieve better energy saving ever.



**ECO G (Gas heat pump).**  
ECO G gas VRF is specially designed for buildings where the electricity is restricted or CO<sub>2</sub> emissions must be reduced. Sanitary hot water is produced freely in 365 days.

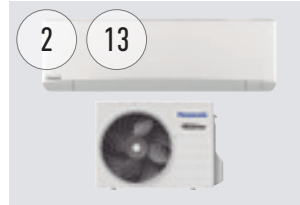

**TKEA outdoor unit for server room.**  
Steady cooling, nonstop, even at -20°C and still with high efficiency. Ready for continuous operation and easy to connect 2 systems to automatically alternate and ensure server rooms are kept cool.

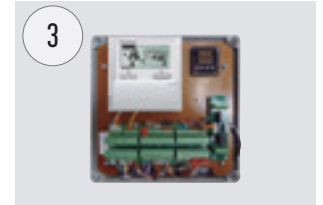

**Air Handling Unit kits for efficient ventilation.**  
The new AHU kit is specially designed to improve the efficiency of the pre-heating or pre-cooling process of the ventilation.

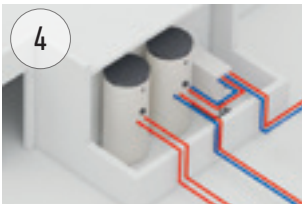

**Domestic Hot Water production and buffer tanks.**  
Panasonic has developed a wide range of efficient domestic hot water tanks and buffer tanks.

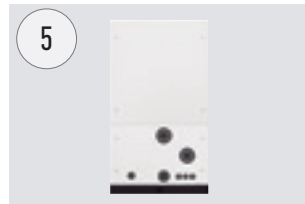

**Hydronic units.**  
For obtaining hot and cold water for heating and refrigeration (Aquarea Air radiators, underfloor heating, radiators...)

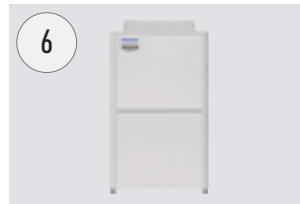

**ECOi (Electric VRF).**  
ECOi electric VRF is specifically designed for the most demanding hotels. High efficiency system. Extended operating range to provide heating at outdoor temperature as low as -25°C.

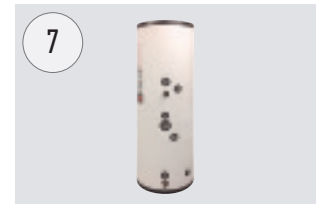

**High temperature DHW tank.**  
DHW tank with maximum outlet temperature 65°C. Ideal solution for high demand of hot water such as shower, spa, swimming pool.

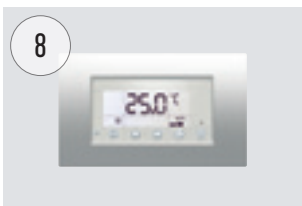

**Control your way.**  
Wide variety of controls, from simple user control to full system control via remote access functionality. Touch panel, web server, consumption control, smartphone control... everything is possible.

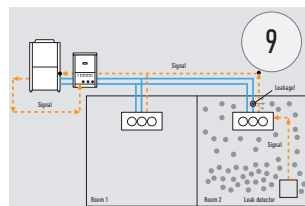

**Direct leak detection method for the safety.**  
Panasonic Pump Down System meets requirements by the Safety of Building Occupant (BS-EN378). The safest solution for hotel rooms.



**Wide range of indoor units.**  
Complete range of indoor units that fits any need. All units provided with supply air temperature sensor and low operation sound level to guarantee maximum guests comfort. From 1,5kW up to 30kW.



**Panasonic AC Smart Cloud.**  
Take control of all your shops around the world from a single device. Centralise control of your business premises, from wherever you are, 24/7.

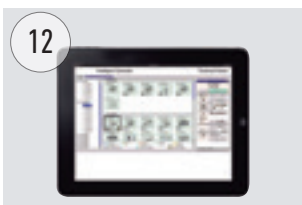

**Protocol friendly.**  
Great flexibility for integration into your KNX / Modbus / LonWorks / BACnet projects allows fully bi-directional monitoring and control of all the functioning parameters.



**Air Curtain with DX Coil.**  
The Panasonic range of air curtains is designed for smooth operation and efficient performance.



**Maximum savings on hot water production.**  
Hot water for swimming pool, spa and laundry for free thanks to the residual heat generated by the ECO G units.



**Condensing unit with natural refrigerant.**  
Panasonic CO<sub>2</sub> unit is the natural choice as energy saving and environmentally friendly solution.

Panasonic offers the widest range in HVAC, DHW and ventilation available. That enables us to offer the most suitable solution 24 hours a day, 365 days a year. Panasonic Solutions ensure not only a higher customer satisfaction but also a lower energy bill.

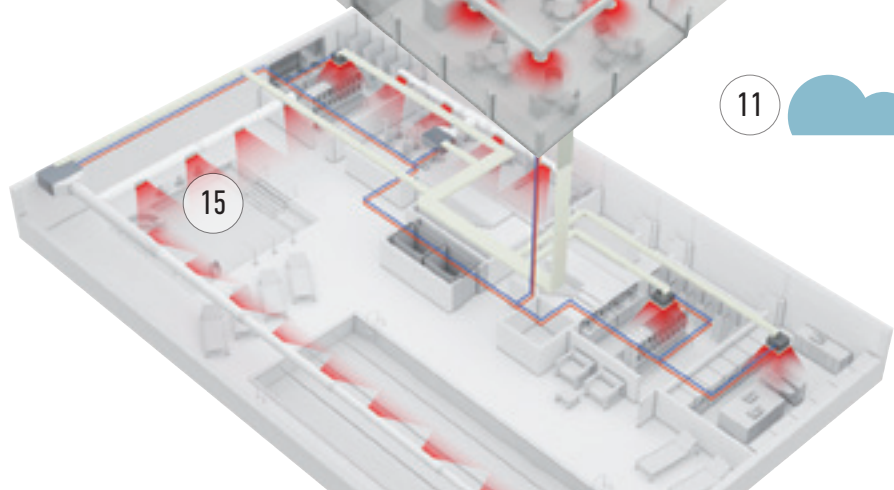
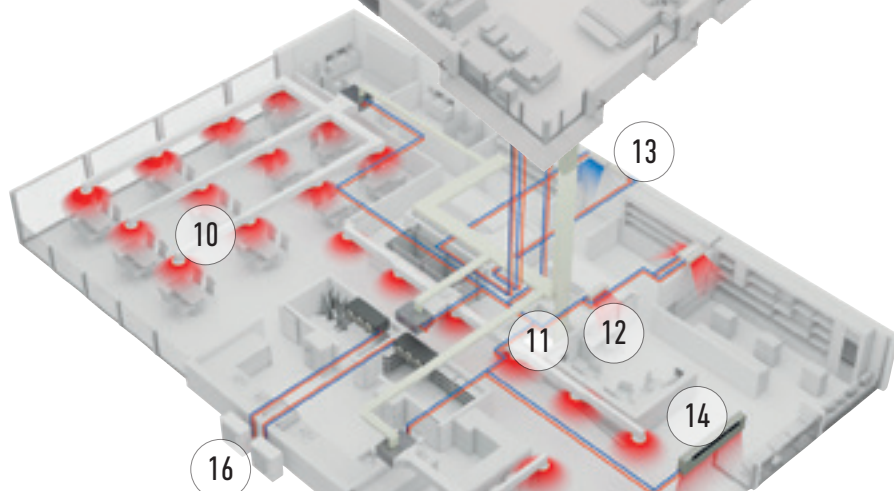
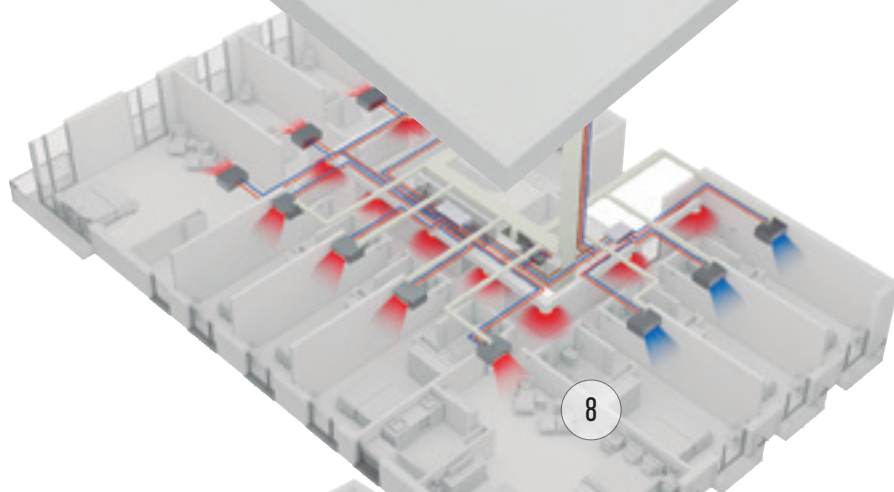
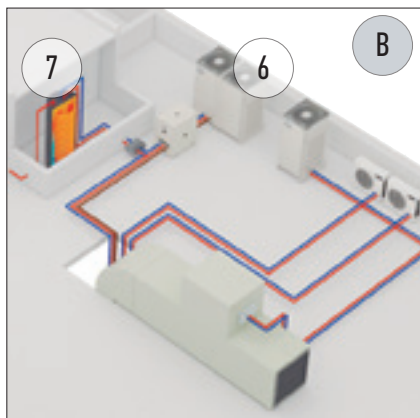
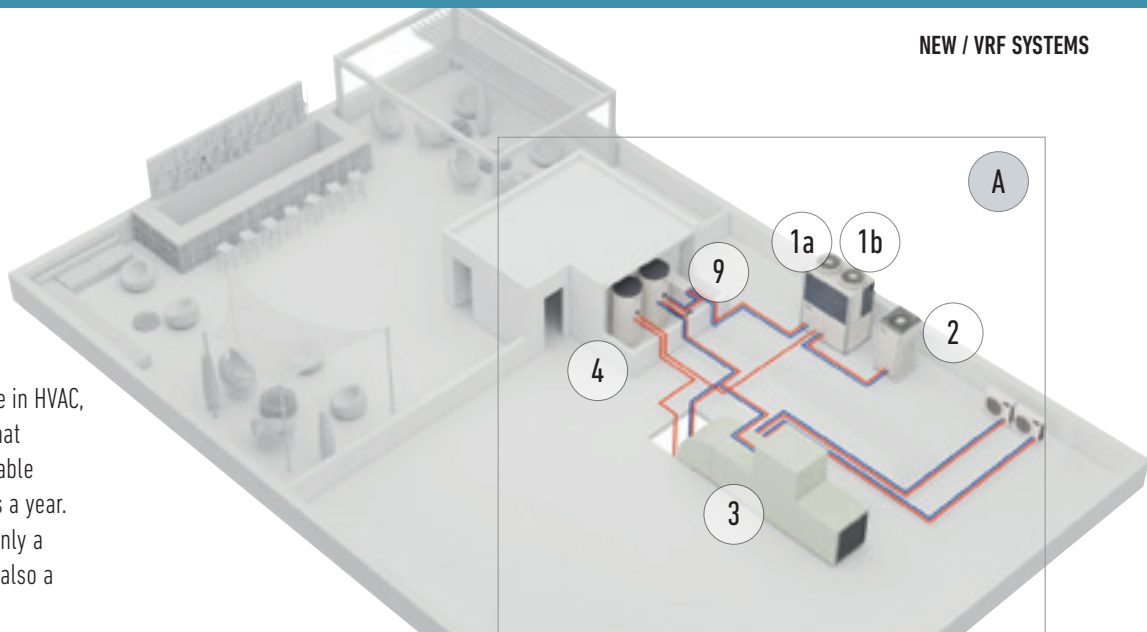

A

**Option A: Hybrid Solution. Gas + Electric: When large quantities of hot/cold water is needed.**

- ECO G (Gas heat pump)
- Water heat exchanger
- Aquarea HT to produce hot water up to 65°C
- Air Handling Unit kit to connect the ECO G to the Air Handling Unit
- TKEA wall mounted to cool the server rooms efficiently

B

**Option B: Full Electric Solution 2 and 3-Pipe. When flexibility is needed and electricity power availability is not an issue.**

- ECOi (Electric VRF)
- Direct expansion indoor units
- Air Handling Unit (AHU) kit to connect the ECOi to the AHU
- TKEA wall mounted to cool the server rooms efficiently
- Panasonic Pump Down System

11



# INNOVATIVE SOLUTIONS FOR RETAIL

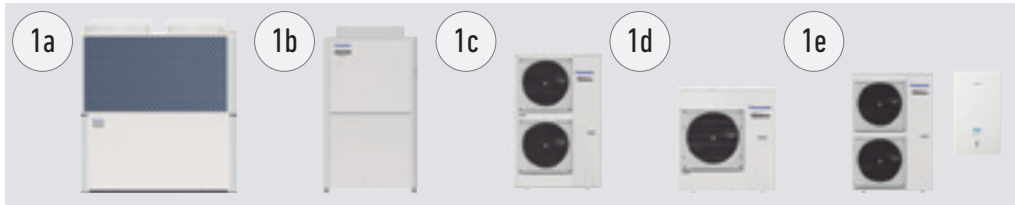

**Multi energy solutions, gas or electric.**

The Multi energy solution (Gas and Electric) from Panasonic gives the best of the energy saving and on the flexibility of the installation. Panasonic solutions can be connect to direct expansion systems, water chiller installations and ventilation systems as air handling units.

- 1a: Gas VRF. ECO G
- 1b: Electric VRF. ECOi
- 1c: Electric VRF. Mini ECOi
- 1d: Electric 1x1. PACi
- 1e: Electric A2W. Aquarea



**PKEA outdoor unit for server room.**

Steady cooling, nonstop, even at -20°C and still with high efficiency. Ready for continuous operation and easy to connect 2 systems to automatically alternate and ensure server rooms are kept cool with maximum operating guaranteed.



**Control your way.**

Wide variety of controls, from simple user control to full system control via remote access functionality. Touch panel, web server, consumption control, smartphone control... everything is possible.

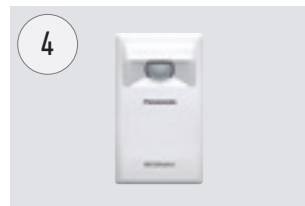

**Econavi Sensor.**

The Econavi Sensor detects presence in the room, and quietly adapts the PACi or VRF air conditioning system in order to improve comfort and energy savings.



**Wide range of indoor units.**

Complete range of indoor units that fits any need. All units provided with supply air temperature sensor and low operation sound level to guarantee guests comfort. From 1,5kW up to 30kW.



**Hide Away, for power and efficiency.**

Super silent units deliver the ideal air supply. Units available from 1,5kW providing precise temperature control even in small rooms. Two models available: slim unit for height restricted areas (MM unit only 200mm deep), another which allows 100% fresh air (MF).



**Air Curtain with DX Coil.**

The Panasonic range of air curtains is designed for smooth operation and efficient performance.

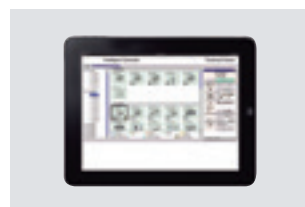

**Protocol friendly.**

Great flexibility for integration into your KNX / Modbus / LonWorks / BACnet projects allows fully bi-directional monitoring and control of all the functioning parameters. Range of solutions to control locally or remotely the full system in bi-directional mode.

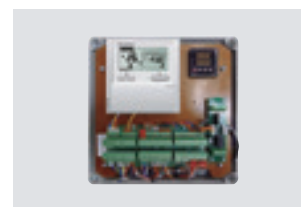

**Air Handling Unit kits for efficient ventilation.**

The new AHU kit is specially designed to improve the efficiency of the pre-heating or pre-cooling process of the ventilation.

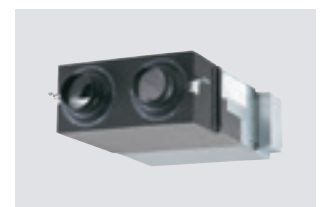

**Energy Recovery unit for high efficiency of the system.**

Panasonic Energy Recovery Ventilators can reduce the outside air load because they efficiently recover the heat lost by ventilation during the heat recovery process.

### Heating and cooling solutions for retail applications

Panasonic has developed solutions for retail applications and office applications where return on investment is a key factor! The comfort inside the shop is key for a good customer experience in the shop. From local control or from Panasonic new cloud control system, a detail status of the heating and cooling system can be displayed, analysed and optimised in order to improve the efficiency, reduce the running time and increase the life time of the units.

### 8 reason why Panasonic is the best solution for your Retail:

- Complete solution
- Flexibility and adaptation
- Go green retail: low CO<sub>2</sub> emissions
- Comfort - high customer satisfaction
- Future expansion
- Panasonic offers efficient systems meeting expectations over the years
- High quality of service with Panasonic pro-partner installation team
- The system will still operate up to 25% of the connected indoor units. System will not stop when up to 25% of indoor units have power supply breakdown when they are on mode

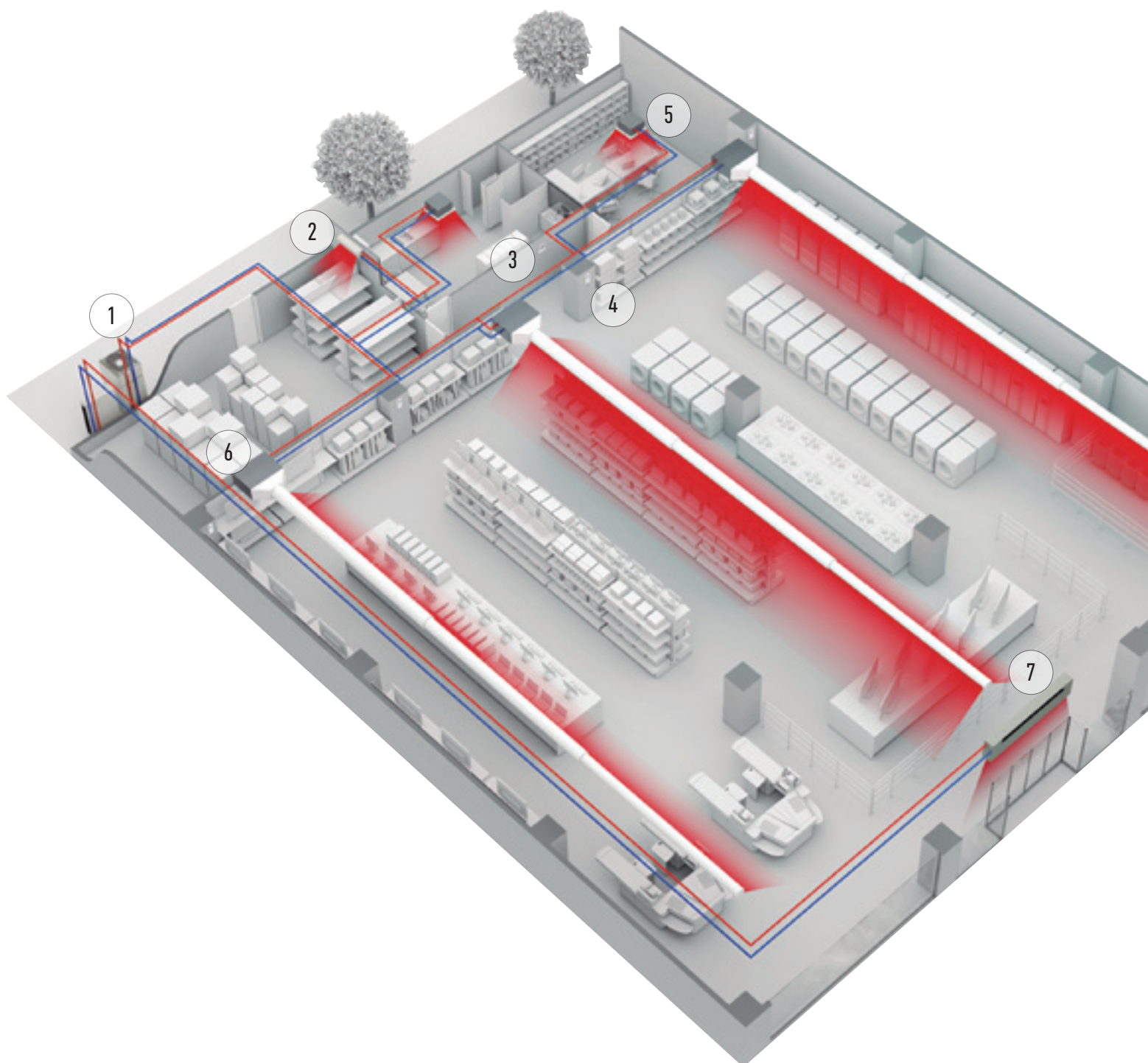

# RANGE OF VRF OUTDOOR UNITS

Page Outdoor units 4HP 5HP 6HP 8HP 10HP 12HP

**P. 244** Mini ECOi LE1 / LE2 Series



U-4LE2E5 / U-4LE2E8



U-5LE2E5 / U-5LE2E8



U-6LE2E5 / U-6LE2E8



U-8LE1E8



U-10LE1E8

**P. 250** 2-Pipe ECOi EX ME2 Series High Efficiency Model



U-8ME2E8



U-10ME2E8



U-12ME2E8

**P. 250** 2-Pipe ECOi EX ME2 Series Space Saving Model



U-8ME2E8



U-10ME2E8



U-12ME2E8

**P. 266** 3-Pipe ECOi MF2 6N Series



U-8MF2E8



U-10MF2E8



U-12MF2E8

**P. 274** 2-Pipe ECO G GE3 Series

**P. 274** 3-Pipe ECO G GF3 Series



14HP

16HP

18HP

20HP

25HP

30HP



U-14ME2E8



U-16ME2E8



U-14ME2E8



U-16ME2E8



U-18ME2E8



U-20ME2E8



U-14MF2E8



U-16MF2E8



U-16GE3E5



U-20GE3E5



U-25GE3E5



U-30GE3E5



U-16GF3E5



U-20GF3E5



U-25GF3E5

# BEST EFFICIENCY ECOi SERIES FROM PANASONIC



The ECOi series is designed for energy savings, easy installation, and high efficiency. Always continuing to evolve, Panasonic uses advanced technologies to meet the requirements of diverse situations and contribute to the creation of comfortable living spaces.

#### Mini ECOi LE Series



The 2-Pipe heat pump small VRF system specifically designed for the European market.

#### 2-Pipe ECOi EX ME2 Series



The VRF system delivering energy-saving performance, powerful operation, reliability and comfort surpassing anything previously possible.

#### 3-Pipe ECOi MF2 6N Series



The VRF system that offers high-efficiency and performance for simultaneous heating and cooling.

#### Lower running and life cycle costs.

Panasonic ECOi systems are highly efficient VRF systems on the market, offering COPs in excess of 4,0 at full load conditions. The system is also designed to make sure that we reduce the running cost of each system by using our unique road map control routine to ensure that the efficient combination of compressors are running at any one time. Improved defrost sequencing also reduces running costs by defrosting each outdoor coil in turn when conditions allow.

Up to 64 indoor units can be connected up to a capacity of 200% indexed indoor unit loads, enabling the system to be used effectively on highly

diversified building loads: this large connectivity feature makes it an easy-to-design solution for schools, hotels, hospitals and other large buildings. Up to 1000m in pipe length enables the VRF ECOi series to be used in very large buildings, with maximum design flexibility. The ECOi system is also easy to control. It has more than 8 types of control from standard wired remote controls to touch screen panels or web access interfaces.

**DC-inverter control technology for rapid and powerful cooling & heating. The ever-evolving Panasonic ECOi series.**

#### ECOi Series benefits

##### Ease of installation.

R410A has a higher operating pressure with a lower pressure loss than previous refrigerants. This enables smaller pipe sizes to be used and allows reduced refrigerant charges.

##### Simple to design.

Panasonic recognise that designing, selecting and preparing a professional VRF quotation can be a time consuming and costly process, especially as it is often also a speculative exercise. So we have designed proprietary software which is quick and easy to use and produces a full schematic layout of pipework and controls, as well as a full materials list and performance data.

##### Easy to control.

A wide variety of control options are available to ensure that the ECOi system provides the user with the degree of control that they desire, from simple room controllers through to state of the art BMS controls.

##### Simple to commission.

Simple set-up procedure including automatic addressing of connected indoor units. Configuration settings can be made from an outdoor unit or via a remote controller.

##### Easy to position.

The compact design of the ECOi outdoor units means that sizes 4HP to 10HP fit into a standard lift and are easy to handle and position when on site. The small footprint and modular appearance of the units ensure a cohesive appearance to an installation.

##### Wide selection and connectivity.

With 11 indoor model styles available, ECOi systems are the ideal choice for multiple small capacity indoor unit installations, with the ability to connect up to 40 indoor units to systems of 24HP or greater for 3-Pipe ECOi MF2 6N Series.

##### Easy to maintain.

Each system allows the use of prognostic and diagnostic controls routines, from refrigerant charge control through to complex fault code diagnostics, all designed to reduce the speed of maintenance calls and unit down time.

##### Lower running and life cycle costs.

Panasonic ECOi system are also designed to make sure that we reduce the running cost of each system by using our unique road map control routine to ensure that the most efficient combination of compressors are running at any one time. Improved defrost sequencing also reduces running costs by defrosting each outdoor coil in turn when conditions allow.

# MINI ECOi LE SERIES FOR LIGHT COMMERCIAL & RESIDENTIAL USE

**NEW  
COMPACT  
DESIGN**

Mini ECOi with extraordinary energy-saving performance and high external static pressure (35Pa).

Advantages of Mini ECOi LE Series used for medium sized buildings.

## 1 Efficiency energy control

Upgraded outdoor units deliver high efficiency rating and reduced energy costs.

## 2 Space saving

Ideal for commercial locations with limited space such as banks and shops.  
Compact units integrate easily and discreetly into building design.

## 3 Flexible installation

Reduced installation time thanks to compact units and extra long piping without additional refrigeration charge. High external static pressure 35Pa and small chassis increase installation options.



**7,85** | **4,87\***  
SEER | SCOP  
**INDUSTRY LEADING  
EFFICIENCY**

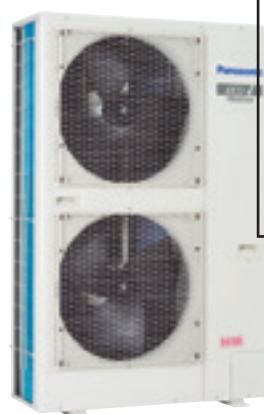

**6,37\***  
SEER  
**4,31**  
SCOP

### New compact design: LE2 Series - 4 / 5 / 6HP

- Extraordinary energy saving: 7,85 SEER and 4,87 SCOP (4HP)\*
- 50 m piping length without additional refrigerant charge
- Quiet operation mode with 4 levels
- High COP mode option

\* SEER/SCOP is calculated based on the seasonal space cooling/heating efficiency "η<sub>1</sub>" values of the COMMISSION REGULATION (EU) 2016/2281. SEER, SCOP = (η<sub>1</sub> + Correction) × PEF.

### LE1 Series - 8 / 10HP

- 60% smaller than ECOi ME2 8 / 10HP with vertical flow type
- Flexible piping length (Total : 300m, Furthest : 150m)
- Maximum number of connectable indoor units: 15

### Key features for LE1 / LE2.

- High external static pressure 35Pa
- Full range of ECOi indoor units and controllers
- Variable evaporation temperature control as standard
- Connectable maximum indoor / outdoor capacity ratio up to 130%
- Auto restart from outdoor units
- Demand response (Peak cut) by optional parts
- Suitable for R22 renewable projects

# INSTALLATION FLEXIBLE, EASY AND HASSLE-FREE

## High external static pressure 35Pa

- High air pressure
- New blade shape
- Good for high class condominiums

When unit is installed on a narrow balcony and exposed to the sun, the barrier at the front side would restrict hot air from being discharged. Heat accumulated in an enclosure can cause over-heating. This could potentially result in damage or shorten the product's life span. A high external static pressure sends the air further away from the outdoor unit and through the barrier. This provides better air circulation and distribution.

And a high air pressure of 35Pa discharges the hot air a sufficient distance.

### Previous Model - Low Pressure

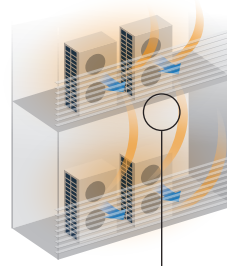

**Heat Accumulated.**  
When the pressure is low, hot air will accumulate in the unit thus affecting its work performance and that of unit above it as well.



### LE Series - High Pressure



**Heat Discharged.**  
But with a high pressure of 35Pa, hot air is sent further away preventing overheating inside the outdoor unit enclosure.



## Long piping design length for greater design flexibility

LE1: Maximum total piping length: 300m.

LE2: Maximum total piping length: 180m.

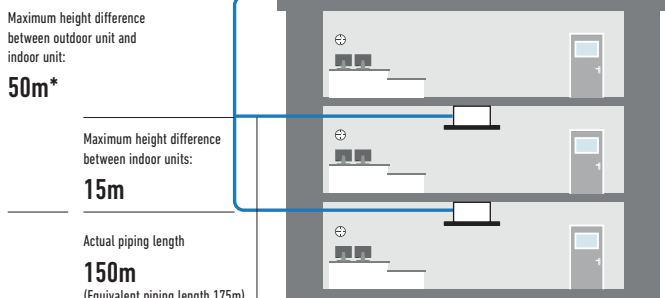

\* 40m if the outdoor unit is below the indoor unit.

## Plug & Play concept

- 50m piping length free of charge
- A 50m pipe length is sufficient for most residential and small business buildings

**FREE OF CHARGE 50m**

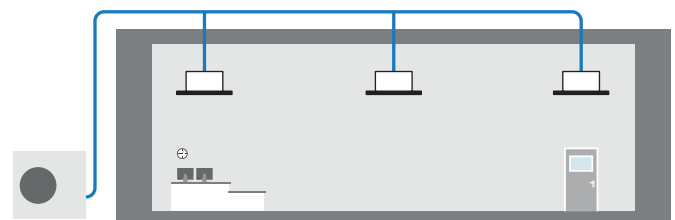

- Compact space-saving design
- High external static pressure 35Pa
- Long piping length for flexible installation
- No refrigeration charge up to 50m
- 130% ratio for connectable indoor capacity units

## Up to 15 indoor units connectable

An expansion from Panasonic VRF line up, the mini ECOi is compatible with the same indoor units and controls as the rest of the ECOi range.

## Compact design

### Mini ECOi LE Series is a single unit.

Perfect for installations with limited space and easy to hide within a modern building. Flexible space-saving options compared to single split system.

### LE2 short height of 996mm.

New LE2 Series is 25% smaller in height than conventional model.



# ENERGY CONTROL & RELIABILITY

## Energy savings design

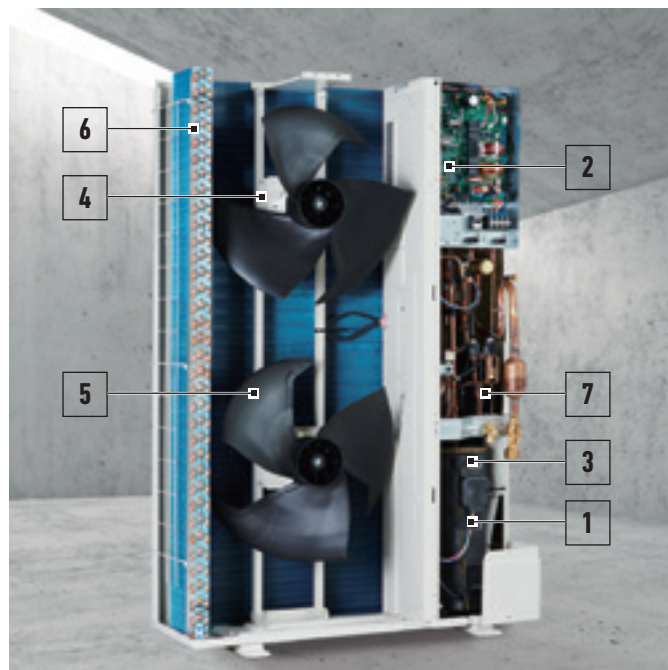

1. **Panasonic Inverter Compressor.** A large-capacity inverter compressor has been adopted. The inverter compressor is superior in performance with improved partial-load capacity.
2. **Printed Circuit Board.** The number of PCB is 2 pieces for making maintenance easier.
3. **Accumulator.** A large accumulator has been adopted to maintain compressor reliability because of the increased refrigerant quantity, which allows an extended maximum piping length.
4. **DC Fan Motor.** Checking load and outside temperature, the DC motor is controlled for optimum air volume.
5. **Newly Designed Fan.** The newly designed fan blades have been developed to inhibit air turbulence and to increase efficiency. As fan diameter has been increased its size, the air volume has been increased whilst maintaining a same sound level.
6. **Heat Exchanger & Copper Tubes.** The heat exchanger size and the copper tube sizes in the heat exchanger have been redesigned to increase efficiency.
7. **Oil Separator.** A centrifugal separator has been adopted to improve oil separation efficiency and reduce refrigerant pressure loss.

## Bluefin condenser: High durability outdoor unit

The anti-corrosion Bluefin treatment of the heat exchanger provides greater resistance against corrosion. All models are equipped with Bluefin condenser and corrosion-resistance treated for high resistance to rust and salty air to assure long-lasting performance.

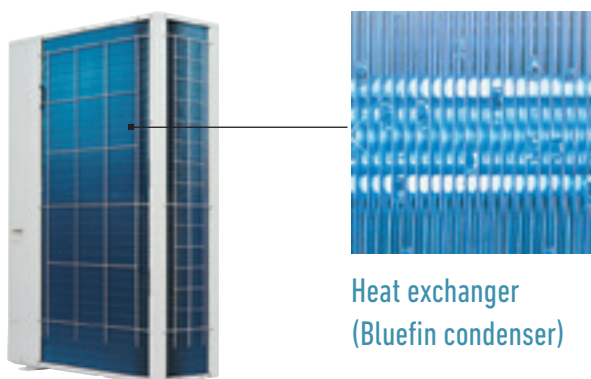

Heat exchanger (Bluefin condenser)

The new Mini ECOi system delivering energy-saving performance, powerful operation, reliability and comfort surpassing anything previously possible.

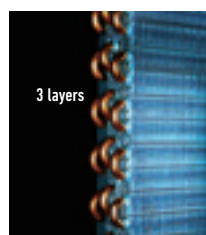

**Powerful heat exchanger.**  
3 layers of heat exchanger for all LE series. LE Series features the same heat exchange volume as conventional model even though it is 15% smaller in size.

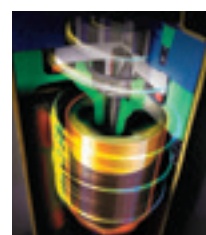

**Panasonic twin Rotary Compressor.**  
A large capacity inverter compressor has been adopted. This new compressor features wider and 0,1Hz step inverter control.



**New design fan.**  
Fan blades have been redesigned to inhibit air resistance and to increase efficiency. The larger fan increases air volume while maintaining low noise levels.

## Superior seasonal energy efficiency

The operation efficiency has been improved using highly efficient R410A refrigerant, a DC Inverter compressor, DC motor and a heat exchanger design.

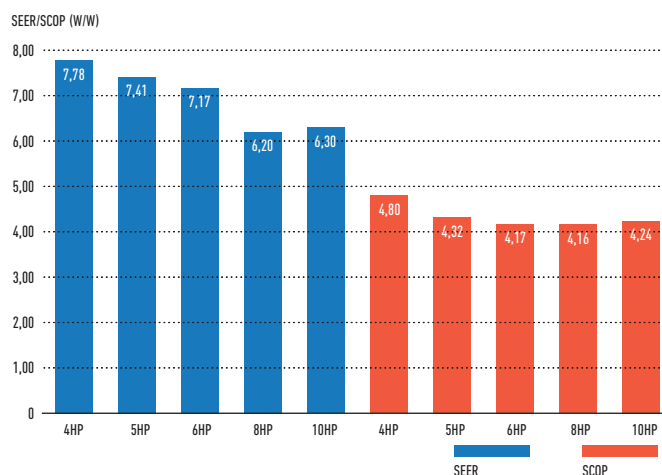

## Maximum comfort with quiet operation mode

- Quiet operation mode reduces outdoor unit operating sound by 7dB(A)
- 4-step set point is available
- Silent mode 1 maintains rated cooling capacity

\* Timer setting of quiet operation mode is available in High-spec remote controller.

Silent mode options	Sound pressure level
Silent mode 1	-1,5dB(A)
Silent mode 2	-3dB(A)
Silent mode 3	-5dB(A)
Silent mode 4	-7dB(A)

# MINI ECOi LE2 SERIES HIGH EFFICIENCY 4 TO 6HP



Panasonic Mini ECOi. Extraordinary energy-saving. The most compact ECOi system ever.

### For light commercial use

Mini ECOi allows easier installation in condominiums and medium sized buildings with limited spaces. Utilising R410A and DC inverter technology, Panasonic offers VRF to a new and growing market.

### Short height of 996m

In addition to raising efficiency, the outdoor unit has been designed to be as compact as possible. It can now be installed in places that were previously too small.

### Technical focus

- Outstanding SEER and SCOP
- Better efficiency even compared to 2 fan outdoor units
- 50m piping length free of refrigeration charge
- 35Pa high static pressure
- High COP mode selectable with maintenance remote controller
- Selectable silent mode

HP			4HP	5HP	6HP	4HP	5HP	6HP
Outdoor Units			U-4LE2E5	U-5LE2E5	U-6LE2E5	U-4LE2E8	U-5LE2E8	U-6LE2E8
Power supply	Voltage	V	220 / 230 / 240	220 / 230 / 240	220 / 230 / 240	380 / 400 / 415	380 / 400 / 415	380 / 400 / 415
	Phase		Single Phase	Single Phase	Single Phase	Three Phase	Three Phase	Three Phase
	Frequency	Hz	50	50	50	50	50	50
Cooling capacity		kW	12,10	14,00	15,50	12,10	14,00	15,50
EER <sup>1)</sup>		W/W	4,50	4,06	3,73	4,50	4,06	3,73
<b>SEER <sup>2)</sup></b>		<b>W/W</b>	<b>7,85</b>	<b>7,48</b>	<b>7,25</b>	<b>7,85</b>	<b>7,48</b>	<b>7,25</b>
Running current cooling		A	13,30 / 12,70 / 12,20	16,30 / 15,60 / 17,00	20,30 / 19,40 / 18,60	4,39 / 4,17 / 4,02	5,58 / 5,30 / 5,11	6,71 / 6,37 / 6,14
Input power cooling		kW	2,69	3,45	4,15	2,69	3,45	4,15
Heating capacity		kW	12,50	16,00	16,5	12,50	16,00	16,50
COP <sup>1)</sup>		W/W	5,19	4,60	4,27	5,19	4,60	4,27
<b>SCOP <sup>2)</sup></b>		<b>W/W</b>	<b>4,87</b>	<b>4,40</b>	<b>4,24</b>	<b>4,87</b>	<b>4,40</b>	<b>4,24</b>
Running current heating		A	12,20 / 11,60 / 11,20	17,60 / 16,80 / 16,10	19,10 / 18,20 / 17,50	3,98 / 3,78 / 3,64	5,62 / 5,34 / 5,14	6,24 / 5,93 / 5,71
Input power heating		kW	2,41	3,48	3,86	2,41	3,48	3,86
Starting current		A	1,00	1,00	1,00	1,00	1,00	1,00
Maximum current		A	17,30	24,30	27,40	7,90	10,10	10,70
Maximum input power		kW	3,50 / 3,66 / 3,82	4,92 / 5,14 / 5,37	5,61 / 5,86 / 6,12	4,34 / 5,09 / 5,28	6,25 / 6,55 / 6,82	6,62 / 6,97 / 7,23
Maximum number of connectable indoor units			7 (10) <sup>3)</sup>	8 (10) <sup>3)</sup>	9 (12) <sup>3)</sup>	7 (10) <sup>3)</sup>	8 (10) <sup>3)</sup>	9 (12) <sup>3)</sup>
External static pressure		Pa	0~35	0~35	0~35	0~35	0~35	0~35
Air volume		m <sup>3</sup> /min	69	72	74	69	72	74
Sound pressure	Cool	dB(A)	52	53	54	52	53	53
	Cool (Silent1 / 2 / 3 / 4)	dB(A)	50,5 / 49 / 47 / 45	51,5 / 50 / 48 / 46	52,5 / 51 / 48 / 46	50,5 / 49 / 49 / 47	48,5 / 50 / 48 / 46	48,5 / 50 / 48 / 46
	Heat	dB(A)	54	56	56	54	56	56
Sound power	Cool / Heat	dB	69 / 72	71 / 75	73 / 75	69 / 72	71 / 75	73 / 75
Dimension	H x W x D	mm	996 x 980 x 370	996 x 980 x 370	996 x 980 x 370	996 x 980 x 370	996 x 980 x 370	996 x 980 x 370
Net weight		kg	106	106	106	106	106	106
Piping connections	Liquid pipe	Inch (mm)	3/8 (9,52)	3/8 (9,52)	3/8 (9,52)	3/8 (9,52)	3/8 (9,52)	3/8 (9,52)
	Gas pipe	Inch (mm)	5/8 (15,88)	5/8 (15,88)	5/8 (15,88)	5/8 (15,88)	5/8 (15,88)	5/8 (15,88)
Maximum piping length (total)		m	150 (180)	150 (180)	150 (180)	150 (180)	150 (180)	150 (180)
Elevation difference (in/out)		m	50 (Outdoor unit upper) / 40 (Outdoor unit lower)	50 (Outdoor unit upper) / 40 (Outdoor unit lower)	50 (Outdoor unit upper) / 40 (Outdoor unit lower)	50 (Outdoor unit upper) / 40 (Outdoor unit lower)	50 (Outdoor unit upper) / 40 (Outdoor unit lower)	50 (Outdoor unit upper) / 40 (Outdoor unit lower)
	Refrigerant (R410A)	kg / TCO <sub>2</sub> Eq.	6,70 (14,40) / 13,9896	6,70 (14,40) / 13,9896	6,70 (14,40) / 13,9896	6,70 (14,40) / 13,9896	6,70 (14,40) / 13,9896	6,70 (14,40) / 13,9896
Maximum allowable indoor / outdoor capacity ratio		%	50~130	50~130	50~130	50~130	50~130	50~130
Operating range	Cool Min ~ Max	°C	-10 ~ +46	-10 ~ +46	-10 ~ +46	-10 ~ +46	-10 ~ +46	-10 ~ +46
	Heat Min ~ Max	°C	-20 ~ +18	-20 ~ +18	-20 ~ +18	-20 ~ +18	-20 ~ +18	-20 ~ +18

1) EER and COP calculation is based in accordance to EN14511. 2) SEER/SCOP is calculated based on the seasonal space cooling/heating efficiency "η" values of the COMMISSION REGULATION (EU) 2016/2281. SEER, SCOP = (η + Correction) × PEF. 3) In case of 1,5kW indoor unit's connection, able to connect maximum 12 indoor units.



INTERNET CONTROL: Optional.



## MINI ECOi LE1 SERIES

### HIGH EFFICIENCY 8 AND 10HP



Prepare to be blown away by Panasonic's New Mini VRF system. The Mini VRF compact system is the ideal solution for minimum outdoor space. Panasonic extends the Mini VRF range by 8 and 10HP units.

#### Increase external static pressure

When unit is installed on a narrow balcony, the fence at front side will be the obstacle. High external static pressure will overcome this obstacle and maintain operation capacity.

#### High ambient temperature performance

Cooling operation range up to 46°C. The system can maintain the rated (100%) capacity up to 40°C by 8HP model & up to 37°C by 10HP model.

#### Technical focus

- Piping flexibility with 150m maximum length
- High efficiency
- 15 indoor units connectable
- Quiet operation mode (one of the lowest in the market)
- High ambient temp performance
- High static pressure 35Pa

HP			8HP		10HP	
Outdoor Units			U-8LE1E8		U-10LE1E8	
Power supply	Voltage	V	380 / 400 / 415		380 / 400 / 415	
	Phase		Three Phase		Three Phase	
	Frequency	Hz	50		50	
Cooling capacity		kW	22,40		28,00	
EER <sup>1)</sup>		W/W	3,80		3,11	
<b>SEER <sup>2)</sup></b>		<b>W/W</b>	<b>6,27</b>		<b>6,37</b>	
Running current cooling		A	9,60 / 9,15 / 8,80		14,70 / 14,00 / 13,50	
Input power cooling		kW	5,89		9,00	
Heating capacity		kW	25,00		28,00	
COP <sup>1)</sup>		W/W	4,02		3,93	
<b>SCOP <sup>2)</sup></b>		<b>W/W</b>	<b>4,24</b>		<b>4,31</b>	
Running current heating		A	10,20 / 9,65 / 9,30		11,60 / 11,10 / 10,70	
Input power heating		kW	6,22		7,13	
Starting current		A	1,00		1,00	
Maximum current		A	13,70		19,60	
Maximum input power		kW	9,16		13,10	
Maximum number of connectable indoor units			15 <sup>3)</sup>		15 <sup>3)</sup>	
External static pressure		Pa	0~35		0~35	
Air volume		m <sup>3</sup> /min	150		160	
Sound pressure	Cool	dB(A)	60		63	
	Cool (Silent 1 / 2 / 3 / 4)	dB(A)	57 / 55 / 53		60 / 58 / 56	
	Heat	dB(A)	64		65	
Sound power	Cool / Heat	dB	81 / 85		84 / 86	
Dimension	HxWxD	mm	1500x980x370		1500x980x370	
Net weight		kg	132		133	
Piping connections	Liquid pipe	Inch (mm)	3/8 (9,52) <sup>4)</sup> / 1/2 (12,70) <sup>5)</sup>		3/8 (9,52) <sup>4)</sup> / 1/2 (12,70) <sup>5)</sup>	
	Gas pipe	Inch (mm)	3/4 (19,05) <sup>4)</sup> / 7/8 (22,22) <sup>5)</sup>		7/8 (22,22) <sup>4)</sup> / 1 (25,40) <sup>5)</sup>	
Maximum piping length (total)		m	7,5~150 (7,5~300)		7,5~150 (7,5~300)	
Elevation difference (in/out)		m	50 (Outdoor unit upper) / 40 (Outdoor unit lower)		50 (Outdoor unit upper) / 40 (Outdoor unit lower)	
Refrigerant (R410A)		kg / TCO <sub>2</sub> Eq.	6,30 (24,00) / 13,1544		6,60 (24,00) / 13,7808	
Maximum allowable indoor / outdoor capacity ratio		%	50~130		50~130	
Operating range	Cool Min ~ Max	°C	-10~+46		-10~+46	
	Heat Min ~ Max	°C	-20~+18		-20~+18	

1) EER and COP calculation is based in accordance to EN14511. 2) SEER/SCOP is calculated based on the seasonal space cooling/heating efficiency "η" values of the COMMISSION REGULATION (EU) 2016/2281. SEER, SCOP = (η<sub>1</sub> + Correction) × PEFC. 3) If the heating utilized, it is necessary to increase 1 size with respect to the main liquid pipe, depending on the combination of the indoor unit. 4) Under 90m for ultimate indoor unit. 5) Over 90m for ultimate indoor unit. If the longest piping equivalent length exceeds 90m, increase the sizes of the main tubes by 1 rank for gas and liquid pipes.



INTERNET CONTROL: Optional.

# 2-PIPE ECOi EX THE GAME CHANGER



VRF with outstanding energy-saving performance and powerful operation SEER 7,56 (18HP model).



A game-changing VRF system delivering energy-saving performance, powerful operation, reliability and comfort surpassing anything previously possible. It represents a true paradigm shift in air conditioning solutions. Taking quality to the extreme — that's the Panasonic challenge.

## 1 High performance at extreme conditions

ECOi EX is highly reliable, with strong cooling & heating power, even when operating at extreme ambient temperatures. The units can operate at 100% of capacity at 43°C, reaching a great cooling operation up to 52°C and in heating -25°C.

Also, the ECOi EX features include Bluefin in newly designed heat exchanger improving efficiency as well in marine ambient. A silicone coated PCB (Printed Circuit Board) protects the unit from being damaged by environmental factors such as moisture and dust.

## 2 Outstanding efficiency and comfort

The new ECOi EX system is designed to increase energy efficiency by delivering high SEER rating, as well as high efficiency for part-load operations.

The system has reduced energy costs thanks to "All-Inverter Compressors", with independent control to deliver highly flexible performance. Also, the ECOi EX features an enlarged heat exchanger with triple surfaces that allow for improved heat transfer and a newly designed curved air discharge bell-mouth for better aerodynamics. The three-stage oil recovery design makes it able to minimise the frequency of forced oil recovery, leading to reduced energy costs and sustained comfort.

## 3 Superior flexibility

With its up to 1000 meters of pipeline, its maximum 30 meters height difference between indoor units and its 200 meters length, the design possibilities have grown exponentially making the new ECOi EX the ideal air conditioning option for long haul buildings, such as train stations, airports, schools or hospitals. These advantages are enhanced with the wide range of indoor unit models and capacities facilitating the perfect adaptation to all kind of projects. The careful selection of controls and peripherals such as the Pump Down, the AHU or/and the chiller, enables an optimum system use. Connectable maximum allowable indoor / outdoor capacity ratio up to 200%.



# TWIN ROTARY INVERTER COMPRESSOR

## New twin rotary inverter compressor

Two independently controlled inverter compressors achieve high efficiency. Redesigned components in the body provide performance improvement especially in the rated cooling condition and EER performance.

- Wider and flexible control on Inverter compressor
- Better oil lubrication
- Smooth start up



## Extraordinary energy-saving performance

Designed for Actual Operation Performance. Panasonic builds air conditioning systems not only with a high EER for rated operation, but also with Seasonal-EER appropriate to the customer's actual environment of use. For instance, with rated operation, outdoor temperature is constant at 35°C, but in reality the outdoor temperature is continuously changing. Consequently, required air conditioning performance also changes. That's why Panasonic implements the following kind of proprietary control.

1. Set temperature is rapidly attained; full-load operating time is kept to a minimum.
  2. The frequency of forced oil recovery is minimised. The volume of oil within the compressors is monitored precisely by sensors, so forced oil recovery under full-load operation is conducted only when necessary. Since this suppresses noise due to oil recovery, comfort is maintained.
  3. Panasonic pursues a high EER, of course, as well as high EER in part load, for energy saving performance under a broad range of loads.
- Panasonic's design concept contributes to substantial energy cost reductions.

## Compressor efficiency electric system VRF.

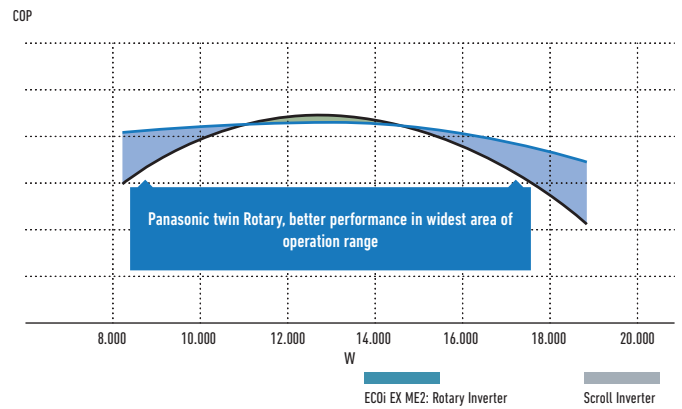

## Number of Inverter compressors

Size	Small		Medium		Large		
HP	8HP	10HP	12HP	14HP	16HP	18HP	20HP
Number	1 pc.		1 pc.	2 pcs.		2 pcs.	

## Actual operation data graph of Panasonic VRF

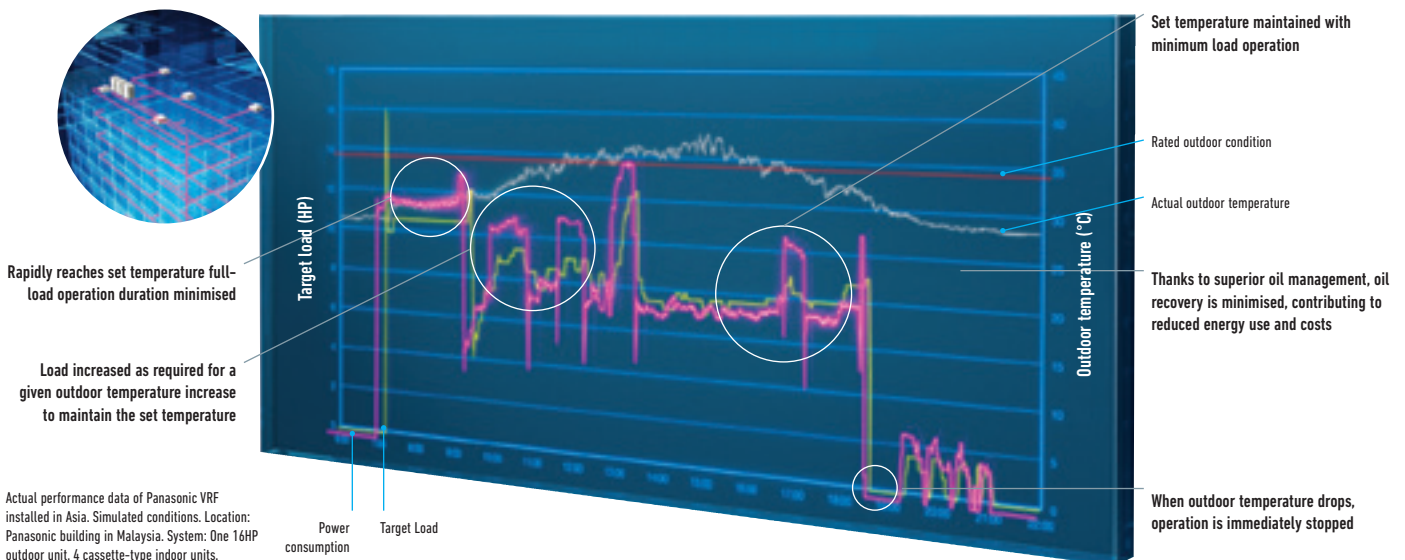

# HIGH PERFORMANCE AT EXTREME CONDITIONS

The ECOi EX can still operate at 100% capacity when the outside temperature is as high as 43°C. This high power capability enables reliable operation even under extremely high temperature conditions.

## Trusted reliability even under high and low temperature conditions

Designed to be durable enough to withstand extreme heat, ECOi EX ensures reliable cooling operation over an extended operation range up to 52°C, and heating operation also at minus -25°C.

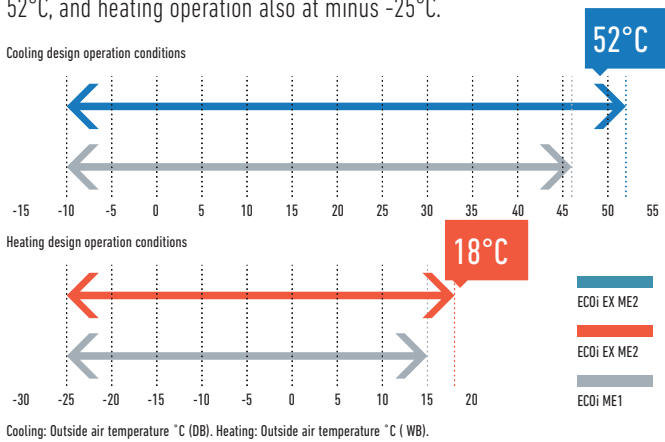

## Extremely high capacity at -20°C and unique heating capacity at -25°C

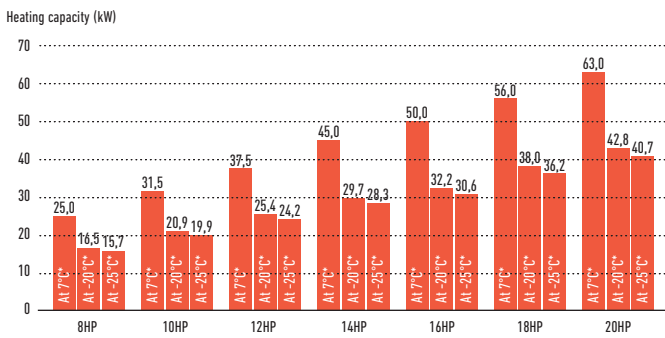

\* Outdoor air temperature (°C WB).

## Hi-durability outdoor unit

Corrosion-resistance treated for high resistance to rust and salty air to assure long-lasting performance.

### Specially protected parts.

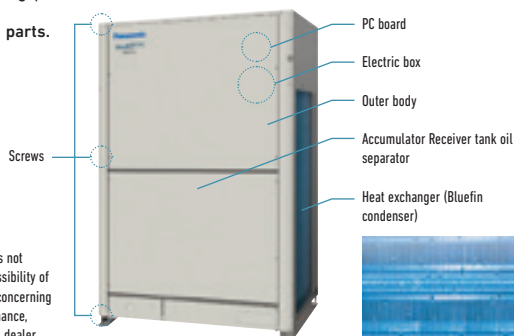

Note: Selecting this unit does not completely eliminate the possibility of rust developing. For details concerning unit installation and maintenance, please consult an authorised dealer.

## Bluefin full line up EX

### Optimised and new design heat exchanger for better surface area with triple surface\*.

The new heat exchanger features a triple-surface construction. Compared to the divided dual-surface construction in current models, there is no division of space and the area for heat exchange is larger. Also, highly efficient piping pattern increases heat exchange performance by 5%.

\* For 8 & 10HP unit, the heat exchanger is 2 row design.

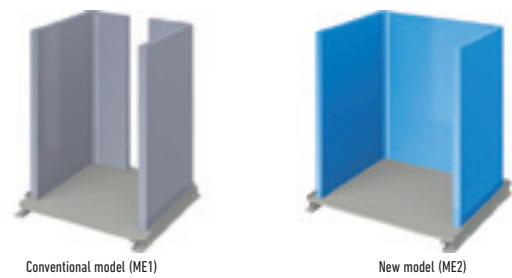

## Extreme outdoor ambient conditions.

Including Bluefin in a newly designed heat exchanger improves efficiency, especially in marine environments. A silicone coated PCB (Printed Circuit Board) protects the unit from being damaged by environmental factors such as moisture and dust.

## High safety operation in case of breakdown!

### Automatic Back-Up operation. Ensures heating and cooling.

It is possible for the system to keep working, even if the compressors, fan motor and the temperature sensor are damaged (even when a compressor fails in single unit with 2 compressors inside).

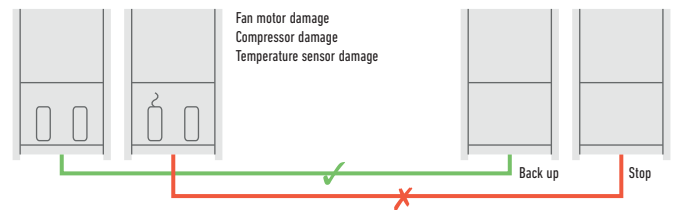

## The system will still operate up to 25% of the connected indoor units.

System will not stop when up to 25% of indoor units have power supply breakdown when they are ON Mode.

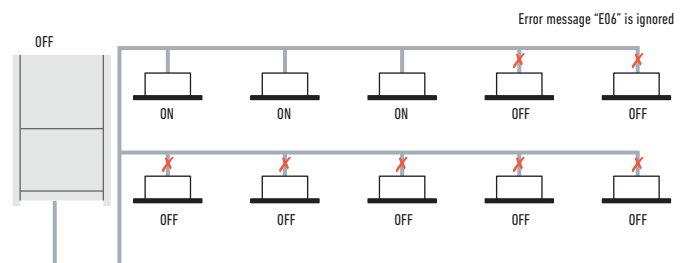

# TOP EFFICIENCY AND COMFORT

Remarkable improvement on key components: extraordinary energy-saving performance and redesigned for smooth and better air discharge.

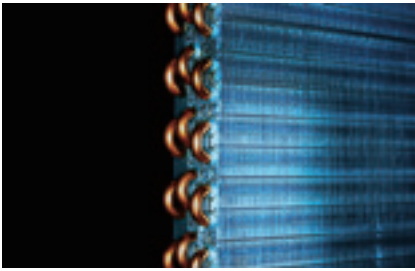

Enlarged heat exchanger surface area with triple surface.

\* For 8 & 10HP unit, the heat exchanger is 2 row design.



Multiple large-capacity all inverter compressors (more than 14HP).



Newly designed curved air discharge bell mouth for better aerodynamics.

## Improvements on refrigerant circuit

### Compressor.

Redesigned components in the body provide performance improvement especially in the rated cooling condition and AEER performance.



### Accumulator.

New oil returning circuit with control valve makes efficient oil recovery to compressor.

### Oil separator.

Modified tank design makes efficient oil separation with less pressure drop.



### Receiver tank less design

Improved refrigerant control program recovers the remaining refrigerant gas in the system back to the accumulator tank effectively.



## Smooth exhaust flow by new bell-mouth

The new curved shape with integrated top and bottom assure smooth exhaust flow. This gives more air-volume with same sound level, less input power at same air volume.

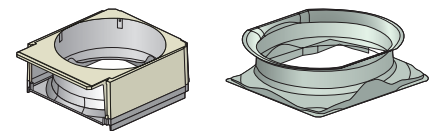

Conventional model (ME1)

New model (ME2)

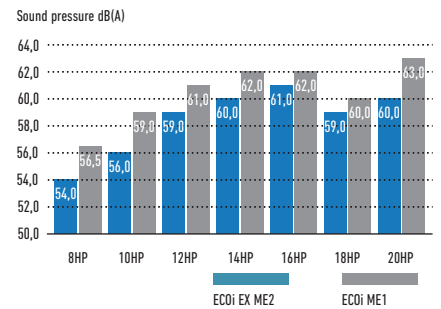

## Combined 3 surface heat exchanger

The highly efficient piping pattern increases heat exchange performance by 5%. The new heat exchanger features a 3 surface construction. Compared to the divided dual-surface construction in current models, there is no divided space and the face area of heat exchanger becomes larger.



Conventional model (ME1)

New model (ME2)

# OIL RECOVERY INTELLIGENT CONTROL

## Intelligent 3-stage Oil Management System

In a VRF system, where lengthy piping and a large number of indoor units need to be controlled collectively, the key to maintaining the system's reliability is to ensure an appropriate amount of oil is secured in the compressors. In order to avoid oil shortage in the compressor, maximum operation is normally forcibly conducted at regular intervals to recover oil from indoor units. This method, typically employed in a standard VRF, causes the system to overheat or overcool and thus waste energy. In Panasonic VRF systems, a sensor for detecting oil levels is mounted in each compressor. In installations with multiple outdoor units, a shortage of oil in one compressor can be compensated for by recovering oil either from another compressor in the same unit, from a compressor in an adjacent outdoor unit, or from a connected indoor unit. Panasonic VRF systems provide users with a comfortable environment whilst saving energy.

### Oil recovery intelligent control advantages:

1. Higher efficiency
2. Durability
3. Comfort:
  - Continuous operation
  - Low noise
  - Low vibration

### Features of oil recovery design

#### Oil sensors installed in each compressor.

Oil sensors installed in each Panasonic compressor precisely monitor oil levels, eliminating unnecessary oil recovery.

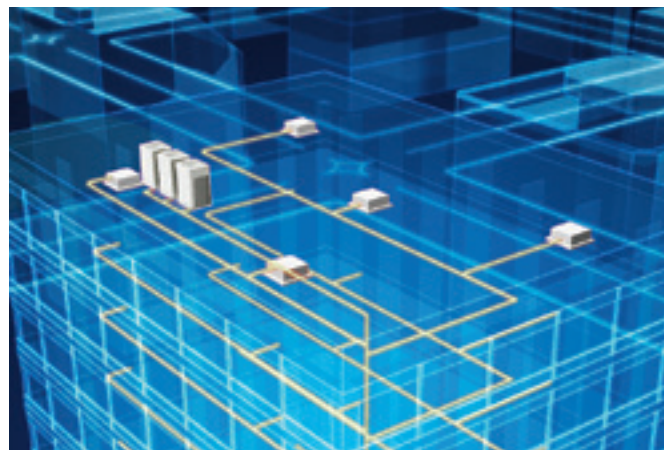
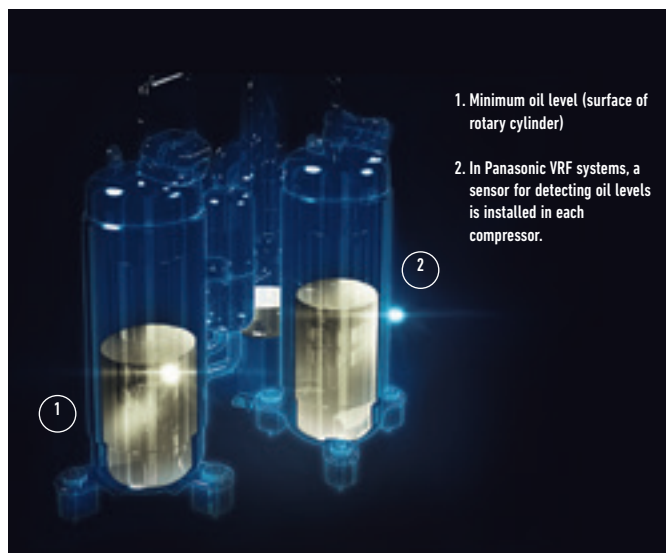

The Panasonic system efficiently manages oil recovery in three stages; minimising the frequency of forced oil recovery while reducing energy cost and maintaining comfort.

**STAGE-1:** Panasonic compressors are equipped with sensors which monitor oil levels precisely at all times. If oil levels fall, oil can be transferred from other compressors within the same outdoor unit.

**STAGE-2:** If oil levels in all compressors within the outdoor unit fall, oil can be replenished from adjacent outdoor units.

**STAGE-3:** Forced oil recovery is implemented only if oil levels become insufficient in spite of above measures. The Panasonic system's design concept is radically different from conventional oil systems.

#### Highly functional oil separator.

Thanks to extended separate piping, oil recovery efficiency reaches 90%, minimising the oil to be discharged from the compressor.



# EXTRAORDINARY PARTIAL LOAD AND SEER/SCOP

## Efficiency in VRF systems

The only way to compare so far, was the nominal efficiency at outdoor ambient temperature of 35°C (EER) in Cooling and at 7°C in heating (COP). With new EN-14825 seasonal efficiency will be shown, the result will be SEER and SCOP. New ECOi EX is reaching excellent performance without using any additional saving functions.

## The highest EER/COP rating in most capacities

### Compared to conventional model ECOi (ME1)

The ECOi EX marks a revolutionary step forward in VRF efficiency. A look at the incredible EER/COP value clearly indicates that. What's more, this high EER/COP value is achieved even during part load operation. This shows the extraordinary energy-saving performance the ECOi EX is capable of providing.

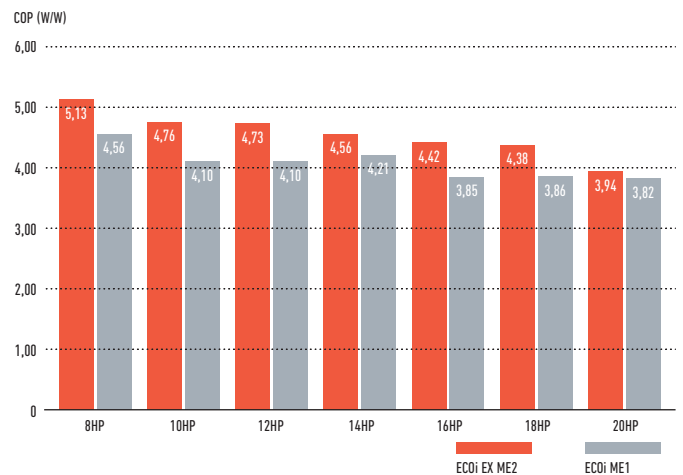
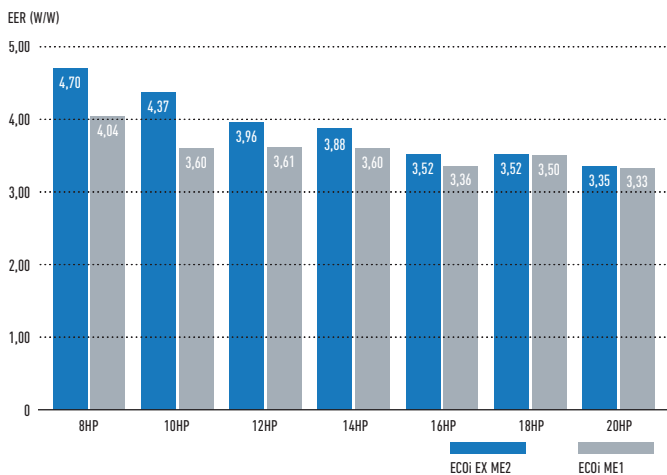

## Partial load for seasonal and real system efficiency

VRF units are designed to adapt to the heating and cooling demand, adapting its performance to different outdoor conditions. When compressor runs at lower than 100% capacity, the system is working at partial load. A wider compressor operating range results in better system performance both at full load and partial load conditions. Panasonic ECOi EX partial load is excellent, reaching a minimum of 15% of compressor capacity.

## Excellent efficiency at any condition and partial load

In both heating and cooling mode, Panasonic ECOi EX is reaching exceptional levels of efficiency.

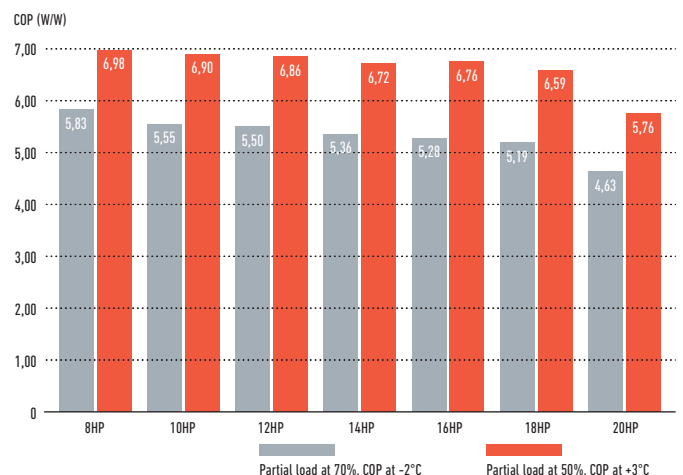
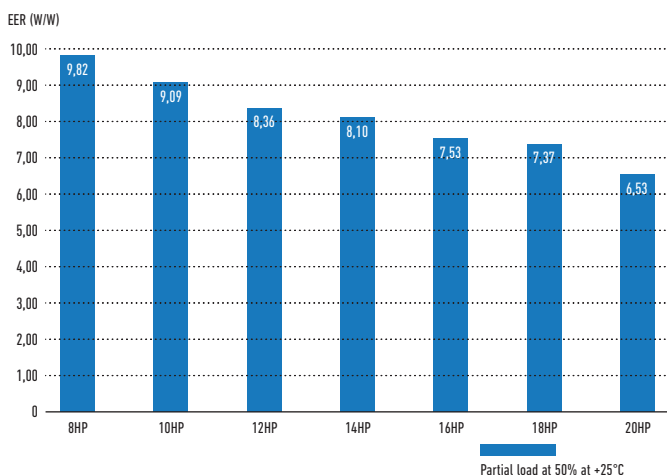



### SEER and SCOP following to EN-14825

When better partial load, better efficiency is achieved in real operation. New EN-14825 is showing the way to calculate considering full year operation hours at different conditions. New Panasonic ECOi EX is designed to save energy in any partial load conditions. Most of operation hours system is under partial load conditions, 80% of total operation hours is less than 70% of full load.

In below graphs is the example for average ambient conditions, this uses Strasbourg ambient conditions for calculation.

#### Outside temperature distribution

Time distribution (hours / year)

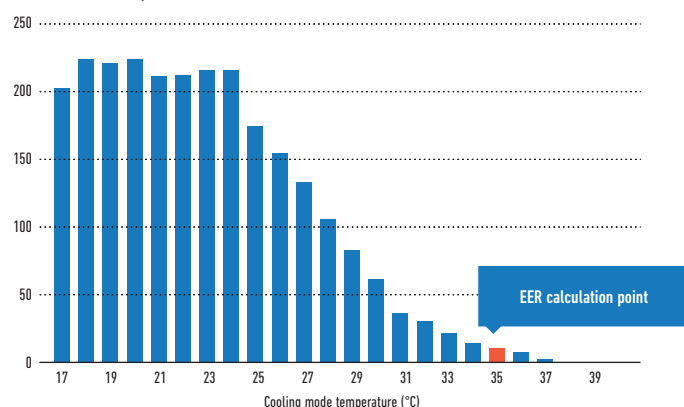

#### Outside temperature distribution

Time distribution (hours / year)

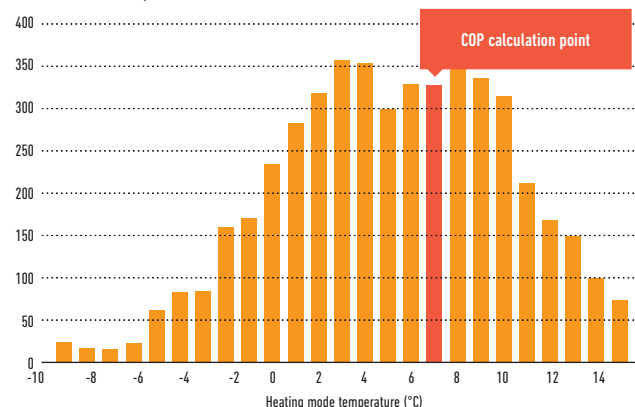

In the characteristics EER and COP only a single temperature for the assessment of the efficiency is taken as a basis in each case. Data calculated under EN-14825 conditions, not additional saving function considered for this calculation. Compressor frequency according to ambient temperature and building design.

### SEER and SCOP values

ECOi EX models have superior seasonal space cooling/heating efficiency following not only EN 14825 but also COMMISSION REGULATION (EU) 2016/2281. This regulation requires to use "η" values in the technical documents from January 2018.

Please visit our websites [www.aircon.panasonic.eu](http://www.aircon.panasonic.eu) or [www.ptc.panasonic.eu](http://www.ptc.panasonic.eu).

SEER/SCOP (W/W)

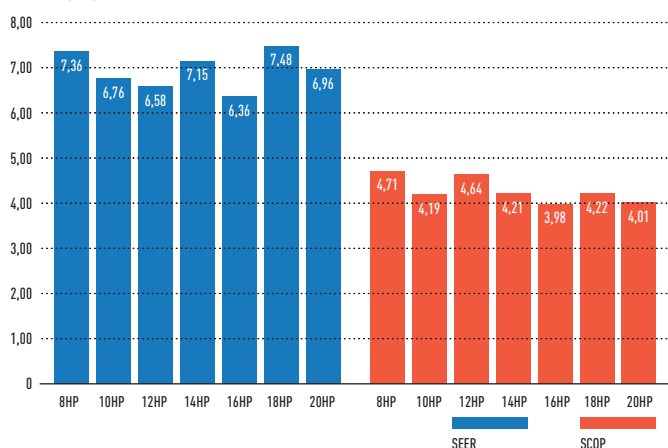

However, if it was necessary by setting on commissioning Panasonic, can increase efficiency additionally by "20%" increasing evaporation refrigerant temperature range, for a higher efficiency and lower energy consumption.

ESEER (W/W)

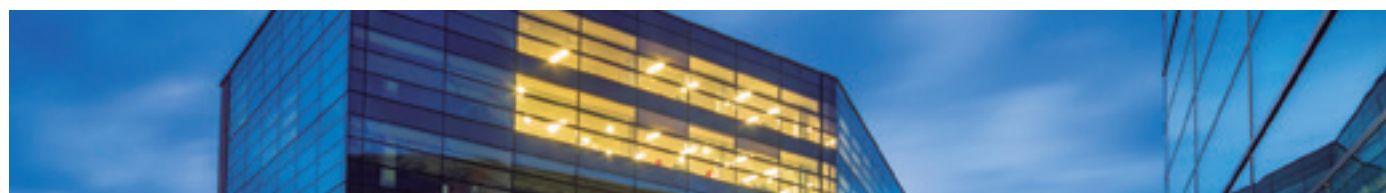
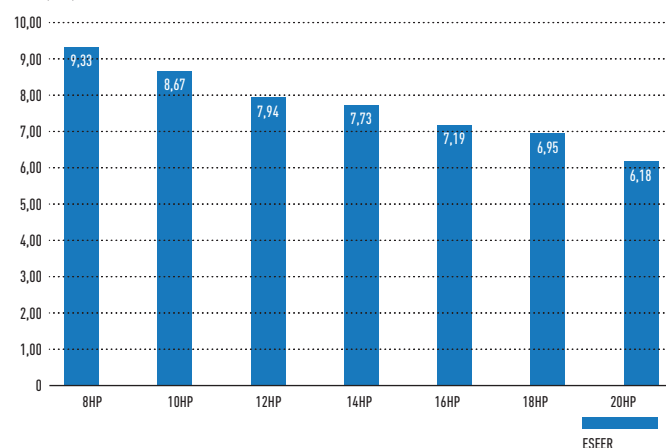



# PIPING DESIGN

Select installation locations so that the lengths and sizes of refrigerant piping are within the allowable ranges shown in the figure below.

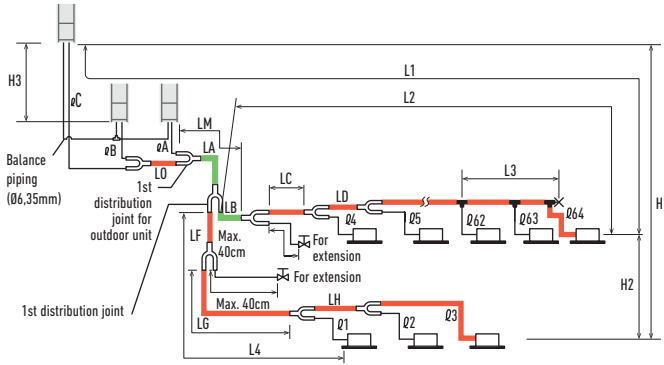

- Main piping length (maximum piping size) LM= LA + LB ...
  - Main distribution tubes LC - LH are selected according to the capacity after the distribution joint.
  - Sizes of indoor unit connection piping Ø1 - Ø64 are determined by the connection piping sizes on the indoor units.
  - Distribution joint (CZ: optional parts)
  - T-joint (field supply)
  - Ball valve (field supply)
  - Solidly welded shut (pinch weld)
- The outdoor connection main piping (LO portion) is determined by the total capacity of the outdoor units that are connected to the tube ends.  
 Note: Be sure to use special R410A distribution joints (CZ: optional parts) for outdoor unit connections and piping branches.
- R410A distribution joint.**  
 CZ-P680PJ2 (for outdoor unit)  
 CZ-P1350PJ2 (for outdoor unit)  
 CZ-P160BK2 (for indoor unit)  
 CZ-P680BK2 (for indoor unit)  
 CZ-P1350BK2 (for indoor unit)

## Ranges that apply to refrigerant piping lengths and to differences in installation heights

Items	Mark	Contents	Length (m)
Allowable piping length	L1	Maximum piping length	Actual length ≤200 <sup>1)</sup> Equivalent length ≤210 <sup>1)</sup>
		Δ L (L2-L4)	Difference between Maximum length and min. length from the 1st distribution joint ≤50 <sup>2)</sup>
	LM	Maximum length of main piping (at maximum size) * Even after 1st distribution joint, LM is allowed if at maximum piping length.	_3)
	Ø1, Ø2- Ø64	Maximum length of each distribution tube	≤50 <sup>4)</sup>
	L1+ Ø1+ Ø2- Ø63+ QA+ QB+LF+LG+LH QA, QB+LO, QC+LO	Total Maximum piping length including length of each distribution tube (only liquid piping) Maximum piping length from outdoor's 1st distribution joint to each outdoor unit	≤1000 ≤10
Allowable elevation difference	H1	When outdoor unit is installed higher than indoor unit	≤50
	H2	When outdoor unit is installed lower than indoor unit	≤40
	H3	Maximum difference between indoor units	≤15 <sup>5)</sup>
Allowable length of joint piping	L3	T-joint piping (field-supply); Maximum piping length between the first T-joint and solidly welded-shut end point	≤2

L = Length, H = Height

1) If the longest piping length (L1) exceeds 90m (equivalent length), increase the sizes of the main tubes (LM) by 1 rank for gas tubes and liquid tubes. Use a field supply reducer. Select the tube size from the table of main piping sizes (Table 3) and from the table of refrigerant piping sizes (Table 8) on the second following page. 2) When the piping length exceeds 40m, increase a longer liquid or gas piping by 1 rank. Refer to the Technical Data for the details. 3) If the longest main piping length (LM) exceeds 50m, increase the main piping size at the portion before 50m by 1 rank for the gas tubes. Use a field supply reducer. Determine the length less than the limitation of allowable maximum piping length. For the portion that exceeds 50m, set based on the main piping size (LA) listed in Table 3. 4) If any of the piping length exceeds 30m, increase the size of the liquid and gas tubes by 1 rank. 5) If the total distribution piping length exceeds 500m, maximum allowable elevation difference (H2) between the indoor units is calculated by the following formula. Make sure the indoor unit's actual elevation difference should fall within the figure calculated as follows. Unit of account (meter): 15 x (2 - total piping length(m) ÷ 500)  
 \* The outdoor connection main piping (LO portion) is determined by the total capacity of the outdoor units that are connected to the tube ends. If the size of the existing piping is already larger than the standard piping size, it is not necessary to further increase the size. \*\* If the existing piping is used, and the amount of on-site refrigerant charge exceeds the value listed below, then change the size of the piping to reduce the amount of refrigerant. Total amount of refrigerant for the system with 1 outdoor unit: 50kg. Total amount of refrigerant for the system with 2 outdoor units: 80kg. Total amount of refrigerant for the system with 3 outdoor units or 4 outdoor units: 105kg.

## Necessary amount of additional refrigerant charge per outdoor unit.

U-8ME2E8	U-10ME2E8	U-12ME2E8	U-14ME2E8	U-16ME2E8
5,5kg	5,5kg	7,0kg	7,0kg	7,0kg

## System limitations.

Maximum number allowable connected outdoor units	4 <sup>1)</sup>
Maximum capacity allowable connected outdoor units	224kW (80HP)
Maximum connectable indoor units	64 <sup>2)</sup>
Maximum allowable indoor / outdoor capacity ratio	50-130% <sup>3)</sup>

- 1) Up to 4 units can be connected if the system has been extended.
- 2) In the case of 38HP or smaller units, the number is limited by the total capacity of the connected indoor units.
- 3) If the following conditions are satisfied, the effective range is above 130% and below 200%.
  - i) Obey the limited number of connectable indoor units.
  - ii) The lower limit of operating range for heating outdoor temperature is limited to -10°C WB (standard -25°C WB).
  - iii) Simultaneous operation is limited to less than 130% of connectable indoor units.

## Additional refrigerant charge.

Liquid piping size Inch (mm)	Amount of refrigerant charge/m (g/m)
1/4 (6,35)	26
3/8 (9,52)	56
1/2 (12,70)	128
5/8 (15,88)	185
3/4 (19,05)	259
7/8 (22,22)	366
1 (25,40)	490

## Refrigerant piping (existing piping can be used).

Piping size (mm)						Material Temper - 0						Material Temper - 1/2 H, H					
Ø6,35	Ø8	Ø12,7	Ø15,88	Ø19,05	Ø22,22	Ø25,4	Ø28,58	Ø31,75	Ø38,1	Ø44,45	Ø48,27	Ø54,61	Ø60,96	Ø67,30	Ø73,65	Ø80,00	
Ø9,52	Ø12,7	Ø15,88	Ø19,05	Ø22,22	Ø25,4	Ø28,58	Ø31,75	Ø38,1	Ø44,45	Ø48,27	Ø54,61	Ø60,96	Ø67,30	Ø73,65	Ø80,00	Ø86,35	

\* When bending the tubes, use a bending radius that is at least 4 times the outer diameter of the tubes. In addition, take sufficient care to avoid crushing or damaging the tubes when bending them.

## 2-PIPE ECOi EX ME2 SERIES HIGH EFFICIENCY MODEL

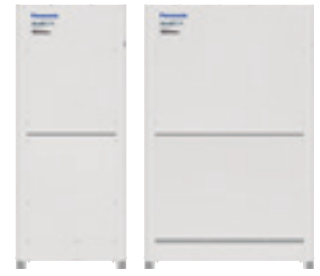

A VRF system delivering energy-saving performance, powerful operation, reliability and comfort surpassing anything previously possible. It represents a true paradigm shift in air conditioning solutions.

VRF with outstanding energy-saving performance and powerful operation SEER 7,56 (18HP model).

### Technical focus

- New twin rotary inverter compressor
- High performance at extreme conditions
- Outstanding efficiency and comfort
- Extraordinary partial load and SEER/SCOP
- SEER and SCOP following to EN-14825
- Oil recovery intelligent control
- Top comfort
- Superior flexibility
- Bluefin full line up EX
- Extremely high capacity at -20°C and unique heating capacity at -25°C
- Smooth exhaust flow by new bell-mouth

			8HP	10HP	12HP	14HP	16HP
Outdoor Units			U-8ME2E8	U-10ME2E8	U-12ME2E8	U-14ME2E8	U-16ME2E8
Power supply	Voltage	V	380 / 400 / 415	380 / 400 / 415	380 / 400 / 415	380 / 400 / 415	380 / 400 / 415
	Phase		Three Phase	Three Phase	Three Phase	Three Phase	Three Phase
	Frequency	Hz	50	50	50	50	50
Cooling capacity		kW	22,40	28,00	33,50	40,00	45,00
EER <sup>1)</sup>		W/W	4,70	4,37	3,96	3,88	3,52
ESEER		W/W	9,33	8,67	7,94	7,73	7,19
<b>SEER <sup>2)</sup></b>		<b>W/W</b>	<b>7,43</b>	<b>6,83</b>	<b>6,65</b>	<b>7,23</b>	<b>6,43</b>
Running current cooling		A	7,40 / 7,14	10,20 / 9,80	13,00 / 12,50	16,50 / 15,90	20,10 / 19,40
Input power cooling		kW	4,77	6,41	8,47	10,30	12,80
Heating capacity		kW	25,00	31,50	37,50	45,00	50,00
COP <sup>1)</sup>		W/W	5,13	4,76	4,73	4,56	4,42
<b>SCOP <sup>2)</sup></b>		<b>W/W</b>	<b>4,79</b>	<b>4,26</b>	<b>4,72</b>	<b>4,28</b>	<b>4,05</b>
Running current heating		A	7,56 / 7,29	10,50 / 10,10	12,30 / 11,80	15,80 / 15,20	17,90 / 17,30
Input power heating		kW	4,87	6,62	7,92	9,86	11,30
Starting current		A	1,00	1,00	1,00	2,00	2,00
External static pressure (Max)		Pa	80	80	80	80	80
Air volume		m <sup>3</sup> /min	224	224	232	232	232
Sound pressure	Normal mode	dB(A)	54	56	59	60	61
	Silent mode	dB(A)	51	53	56	57	58
Sound power	Normal mode	dB	75	77	80	81	82
Dimension	HxWxD	mm	1842x770x1000	1842x770x1000	1842x1180x1000	1842x1180x1000	1842x1180x1000
Net weight		kg	210	210	270	315	315
Piping connections <sup>3)</sup>	Liquid pipe	Inch (mm)	3/8(9,52) / 1/2(12,70)	3/8(9,52) / 1/2(12,70)	1/2(12,70) / 5/8(15,88)	1/2(12,70) / 5/8(15,88)	1/2(12,70) / 5/8(15,88)
	Gas pipe	Inch (mm)	3/4(19,05) / 7/8(22,22)	7/8(22,22) / 1(25,40)	1(25,40) / 1-1/8(28,58)	1(25,40) / 1-1/8(28,58)	1-1/8(28,58) / 1-1/4(31,75)
	Balance pipe	Inch (mm)	1/4(6,35)	1/4(6,35)	1/4(6,35)	1/4(6,35)	1/4(6,35)
Refrigerant (R410A)		kg / TCO <sub>2</sub> Eq.	5,60 / 11,6928	5,60 / 11,6928	8,30 / 17,3304	8,30 / 17,3304	8,30 / 17,3304
Maximum allowable indoor / outdoor capacity ratio % <sup>4)</sup>			50 ~ 130 (200)	50 ~ 130 (200)	50 ~ 130 (200)	50 ~ 130 (200)	50 ~ 130 (200)
Operating range	Cool Min ~ Max	°C	-10 ~ +52	-10 ~ +52	-10 ~ +52	-10 ~ +52	-10 ~ +52
	Heat Min ~ Max	°C	-25 ~ +18	-25 ~ +18	-25 ~ +18	-25 ~ +18	-25 ~ +18

1) EER and COP calculation is based in accordance to EN14511. 2) SEER/SCOP is calculated based on the seasonal space cooling/heating efficiency "η" values of the COMMISSION REGULATION (EU) 2016/2281. SEER, SCOP = (η + Correction) × PEF. 3) Pipe diameter under 90m for ultimate indoor unit / over 90m for ultimate indoor unit (if the longest piping equivalent length exceeds 90m, increase the sizes of the main tubes by 1 rank for gas tubes and liquid tubes). 4) If the following conditions are satisfied, the effective range is above 130% and below 200%: A. Obey the limited number of connectable indoor units. B. The lower limit of operating range for heating outdoor temperature is limited to -10°C WB (standard -25°C WB). C. Simultaneous operation is limited to less than 130% of connectable indoor units.



## 2-PIPE ECOi EX ME2 SERIES SPACE SAVING MODEL



A VRF system delivering energy-saving performance, powerful operation, reliability and comfort surpassing anything previously possible. It represents a true paradigm shift in air conditioning solutions.

VRF with outstanding energy-saving performance and powerful operation SEER 7,56 (18HP model).

### Technical focus

- New twin rotary inverter compressor
- High performance at extreme conditions
- Outstanding efficiency and comfort
- Extraordinary partial load and SEER/SCOP
- SEER and SCOP following to EN-14825
- Oil recovery intelligent control
- Top comfort
- Superior flexibility
- Bluefin full line up EX
- Extremely high capacity at -20°C and unique heating capacity at -25°C
- Smooth exhaust flow by new bell-mouth

			8HP	10HP	12HP	14HP	16HP	18HP	20HP
Outdoor Units			U-8ME2E8	U-10ME2E8	U-12ME2E8	U-14ME2E8	U-16ME2E8	U-18ME2E8	U-20ME2E8
Power supply	Voltage	V	380 / 400 / 415	380 / 400 / 415	380 / 400 / 415	380 / 400 / 415	380 / 400 / 415	380 / 400 / 415	380 / 400 / 415
	Phase		Three Phase	Three Phase	Three Phase	Three Phase	Three Phase	Three Phase	Three Phase
	Frequency	Hz	50	50	50	50	50	50	50
Cooling capacity		kW	22,40	28,00	33,50	40,00	45,00	50,00	56,00
EER <sup>1)</sup>		W/W	4,70	4,37	3,96	3,88	3,52	3,52	3,35
ESEER		W/W	9,33	8,67	7,94	7,73	7,19	6,95	6,18
SEER <sup>2)</sup>		W/W	<b>7,43</b>	<b>6,83</b>	<b>6,65</b>	<b>7,23</b>	<b>6,43</b>	<b>7,56</b>	<b>7,03</b>
Running current cooling		A	7,40 / 7,14	10,20 / 9,80	13,00 / 12,50	16,50 / 15,90	20,10 / 19,40	22,00 / 21,20	25,40 / 24,50
Input power cooling		kW	4,77	6,41	8,47	10,30	12,80	14,20	16,70
Heating capacity		kW	25,00	31,50	37,50	45,00	50,00	56,00	63,00
COP <sup>1)</sup>		W/W	5,13	4,76	4,73	4,56	4,42	4,38	3,94
SCOP <sup>2)</sup>		W/W	<b>4,79</b>	<b>4,26</b>	<b>4,72</b>	<b>4,28</b>	<b>4,05</b>	<b>4,29</b>	<b>4,09</b>
Running current heating		A	7,56 / 7,29	10,50 / 11,10	12,30 / 11,80	15,80 / 15,20	17,90 / 17,30	20,10 / 19,40	24,60 / 23,70
Input power heating		kW	4,87	6,62	7,92	9,86	11,30	12,80	16,00
Starting current		A	1,00	1,00	1,00	2,00	2,00	2,00	2,00
External static pressure (Max)		Pa	80	80	80	80	80	80	80
Air volume		m <sup>3</sup> /min	224	224	232	232	232	405	405
Sound pressure	Normal mode	dB(A)	54	56	59	60	61	59	60
	Silent mode	dB(A)	51	53	56	57	58	56	57
Sound power	Normal mode	dB	75	77	80	81	82	80	81
Dimension	HxWxD	mm	1842x770 x1000	1842x770 x1000	1842x1180 x1000	1842x1180 x1000	1842x1180 x1000	1842x1540 x1000	1842x1540 x1000
Net weight		kg	210	210	270	315	315	375	375
Piping connections <sup>3)</sup>	Liquid pipe	Inch (mm)	3/8 (9,52) / 1/2 (12,70)	3/8 (9,52) / 1/2 (12,70)	1/2 (12,70) / 5/8 (15,88)	1/2 (12,70) / 5/8 (15,88)	1/2 (12,70) / 5/8 (15,88)	5/8 (15,88) / 3/4 (19,05)	5/8 (15,88) / 3/4 (19,05)
	Gas pipe	Inch (mm)	3/4 (19,05) / 7/8 (22,22)	7/8 (22,22) / 1 (25,40)	1 (25,40) / 1-1/8 (28,58)	1 (25,40) / 1-1/8 (28,58)	1-1/8 (28,58) / 1-1/4 (31,75)	1-1/8 (28,58) / 1-1/4 (31,75)	1-1/8 (28,58) / 1-1/4 (31,75)
	Balance pipe	Inch (mm)	1/4 (6,35)	1/4 (6,35)	1/4 (6,35)	1/4 (6,35)	1/4 (6,35)	1/4 (6,35)	1/4 (6,35)
Refrigerant (R410A)		kg / TCO <sub>2</sub> Eq.	5,60 / 11,6928	5,60 / 11,6928	8,30 / 17,3304	8,30 / 17,3304	8,30 / 17,3304	9,50 / 19,836	9,50 / 19,836
Maximum allowable indoor / outdoor capacity ratio % <sup>4)</sup>			50 ~ 130 (200)	50 ~ 130 (200)	50 ~ 130 (200)	50 ~ 130 (200)	50 ~ 130 (200)	50 ~ 130 (200)	50 ~ 130 (200)
Operating range	Cool Min ~ Max	°C	-10 ~ +52	-10 ~ +52	-10 ~ +52	-10 ~ +52	-10 ~ +52	-10 ~ +52	-10 ~ +52
	Heat Min ~ Max	°C	-25 ~ +18	-25 ~ +18	-25 ~ +18	-25 ~ +18	-25 ~ +18	-25 ~ +18	-25 ~ +18

1) EER and COP calculation is based in accordance to EN14511. 2) SEER/SCOP is calculated based on the seasonal space cooling/heating efficiency "η" values of the COMMISSION REGULATION (EU) 2016/2281. SEER, SCOP = (η + Correction) × PEF. 3) Pipe diameter under 90m for ultimate indoor unit / over 90m for ultimate indoor unit (if the longest piping equivalent length exceeds 90m, increase the sizes of the main tubes by 1 rank for gas tubes and liquid tubes). 4) If the following conditions are satisfied, the effective range is above 130% and below 200%: A. Obey the limited number of connectable indoor units. B. The lower limit of operating range for heating outdoor temperature is limited to -10°C WB (standard -25°C WB). C. Simultaneous operation is limited to less than 130% of connectable indoor units.



## 2-PIPE ECOi EX ME2 SERIES HIGH EFFICIENCY MODEL COMBINATION FROM 18 TO 64HP

### Combination from 18 to 28HP

			18HP	20HP	22HP	24HP	26HP	28HP
Model name			U-8ME2E8 U-10ME2E8	U-10ME2E8 U-10ME2E8	U-10ME2E8 U-12ME2E8	U-12ME2E8 U-12ME2E8	U-10ME2E8 U-16ME2E8	U-12ME2E8 U-16ME2E8
Power supply	Voltage	V	380 / 400 / 415	380 / 400 / 415	380 / 400 / 415	380 / 400 / 415	380 / 400 / 415	380 / 400 / 415
	Phase		Three Phase	Three Phase	Three Phase	Three Phase	Three Phase	Three Phase
	Frequency	Hz	50	50	50	50	50	50
Cooling capacity		kW	50,00	56,00	61,50	68,00	73,00	78,50
EER <sup>1)</sup>		W/W	4,55	4,38	4,13	3,93	3,80	3,69
Running current cooling		A	17,30 / 16,60	20,30 / 19,60	23,10 / 22,30	26,60 / 25,60	30,10 / 29,00	33,10 / 31,90
Input power cooling		kW	11,00	12,80	14,90	17,30	19,20	21,30
Heating capacity		kW	56,00	63,00	69,00	76,50	81,50	87,50
COP <sup>1)</sup>		W/W	4,96	4,77	4,76	4,69	4,55	4,56
Running current heating		A	17,70 / 17,10	20,90 / 20,20	22,70 / 21,90	25,30 / 24,40	28,40 / 27,40	30,10 / 29,00
Input power heating		kW	11,30	13,20	14,50	16,30	17,90	19,20
Starting current		A	2,00	2,00	2,00	2,00	3,00	3,00
External static pressure (Max)		Pa	80	80	80	80	80	80
Air volume		m <sup>3</sup> /min	448	448	456	464	456	464
Sound pressure	Normal / Silent mode	dB(A)	58,50 / 55,50	59,00 / 56,00	61,00 / 58,00	62,00 / 59,00	62,50 / 59,50	63,50 / 60,50
Sound power	Normal mode	dB	79,50	80,00	82,00	83,00	83,50	84,50
Dimension / Net weight	HxWxD	mm / kg	1842 x 1600 x 1000 / 420	1842 x 1600 x 1000 / 420	1842 x 2010 x 1000 / 480	1842 x 2420 x 1000 / 540	1842 x 2010 x 1000 / 535	1842 x 2420 x 1000 / 585
Piping connections <sup>2)</sup>	Liquid pipe	Inch (mm)	5/8(15,88) / 3/4(19,05)	5/8(15,88) / 3/4(19,05)	5/8(15,88) / 3/4(19,05)	5/8(15,88) / 3/4(19,05)	3/4(19,05) / 7/8(22,22)	3/4(19,05) / 7/8(22,22)
	Gas pipe	Inch (mm)	1-1/8(28,58) / 1-1/4(31,75)	1-1/8(28,58) / 1-1/4(31,75)	1-1/8(28,58) / 1-1/4(31,75)	1-1/8(28,58) / 1-1/4(31,75)	1-1/4(31,75) / 1-1/2(38,10)	1-1/4(31,75) / 1-1/2(38,10)
	Balance pipe	Inch (mm)	1/4(6,35)	1/4(6,35)	1/4(6,35)	1/4(6,35)	1/4(6,35)	1/4(6,35)
Refrigerant (R410A)		kg / TCO <sub>2</sub> Eq.	11,20 / 23,3856	11,20 / 23,3856	13,90 / 29,0232	16,60 / 34,6608	13,90 / 29,0232	16,60 / 34,6608
Maximum allowable indoor / outdoor capacity ratio % <sup>3)</sup>			50 ~ 130(200)	50 ~ 130(200)	50 ~ 130(200)	50 ~ 130(200)	50 ~ 130(200)	50 ~ 130(200)
Operating range	Cool / Heat Min ~ Max	°C	-10 ~ +52 / -25 ~ +18	-10 ~ +52 / -25 ~ +18	-10 ~ +52 / -25 ~ +18	-10 ~ +52 / -25 ~ +18	-10 ~ +52 / -25 ~ +18	-10 ~ +52 / -25 ~ +18

### Combination from 30 to 40HP

			30HP	32HP	34HP	36HP	38HP	40HP
Model name			U-14ME2E8 U-16ME2E8	U-16ME2E8 U-16ME2E8	U-10ME2E8 U-12ME2E8 U-12ME2E8	U-12ME2E8 U-12ME2E8 U-12ME2E8	U-10ME2E8 U-12ME2E8 U-16ME2E8	U-12ME2E8 U-12ME2E8 U-16ME2E8
Power supply	Voltage	V	380 / 400 / 415	380 / 400 / 415	380 / 400 / 415	380 / 400 / 415	380 / 400 / 415	380 / 400 / 415
	Phase		Three Phase	Three Phase	Three Phase	Three Phase	Three Phase	Three Phase
	Frequency	Hz	50	50	50	50	50	50
Cooling capacity		kW	85,00	90,00	96,00	101,00	107,00	113,00
EER <sup>1)</sup>		W/W	3,68	3,52	4,05	3,95	3,84	3,75
Running current cooling		A	36,60 / 35,30	40,20 / 38,70	36,80 / 35,50	39,30 / 37,90	43,80 / 42,20	46,70 / 45,00
Input power cooling		kW	23,10	25,60	23,70	25,60	27,90	30,10
Heating capacity		kW	95,00	100,00	108,00	113,00	119,00	127,00
COP <sup>1)</sup>		W/W	4,48	4,42	4,72	4,73	4,61	4,57
Running current heating		A	33,60 / 32,40	35,80 / 34,60	35,90 / 34,60	37,10 / 35,80	40,50 / 39,00	43,60 / 42,00
Input power heating		kW	21,20	22,60	22,90	23,90	25,80	27,80
Starting current		A	4,00	4,00	3,00	3,00	4,00	4,00
External static pressure (Max)		Pa	80	80	80	80	80	80
Air volume		m <sup>3</sup> /min	464	464	688	696	688	696
Sound pressure	Normal / Silent mode	dB(A)	63,50 / 60,50	64,00 / 61,00	63,00 / 60,00	64,00 / 61,00	64,00 / 61,00	64,50 / 61,50
Sound power	Normal mode	dB	84,50	85,00	84,00	85,00	85,00	85,50
Dimension / Net weight	HxWxD	mm / kg	1842 x 2420 x 1000 / 630	1842 x 2420 x 1000 / 630	1842 x 3250 x 1000 / 750	1842 x 3660 x 1000 / 810	1842 x 3250 x 1000 / 795	1842 x 3660 x 1000 / 855
Piping connections <sup>2)</sup>	Liquid pipe	Inch (mm)	3/4(19,05) / 7/8(22,22)	3/4(19,05) / 7/8(22,22)	3/4(19,05) / 7/8(22,22)	3/4(19,05) / 7/8(22,22)	3/4(19,05) / 7/8(22,22)	3/4(19,05) / 7/8(22,22)
	Gas pipe	Inch (mm)	1-1/4(31,75) / 1-1/2(38,10)	1-1/4(31,75) / 1-1/2(38,10)	1-1/4(31,75) / 1-1/2(38,10)	1-1/2(38,10) / 1-5/8(41,28)	1-1/2(38,10) / 1-5/8(41,28)	1-1/2(38,10) / 1-5/8(41,28)
	Balance pipe	Inch (mm)	1/4(6,35)	1/4(6,35)	1/4(6,35)	1/4(6,35)	1/4(6,35)	1/4(6,35)
Refrigerant (R410A)		kg / TCO <sub>2</sub> Eq.	16,60 / 34,6608	16,60 / 34,6608	22,20 / 46,3536	24,90 / 51,9912	22,20 / 46,3536	24,90 / 46,3536
Maximum allowable indoor / outdoor capacity ratio % <sup>3)</sup>			50 ~ 130(200)	50 ~ 130(200)	50 ~ 130(200)	50 ~ 130(200)	50 ~ 130(200)	50 ~ 130(200)
Operating range	Cool / Heat Min ~ Max	°C	-10 ~ +52 / -25 ~ +18	-10 ~ +52 / -25 ~ +18	-10 ~ +52 / -25 ~ +18	-10 ~ +52 / -25 ~ +18	-10 ~ +52 / -25 ~ +18	-10 ~ +52 / -25 ~ +18

Data is for reference. 1) EER and COP calculation is based in accordance to EN14511. 2) Pipe diameter under 90m for ultimate indoor unit / over 90m for ultimate indoor unit (if the longest piping equivalent length exceeds 90m, increase the sizes of the main tubes by 1 rank for gas tubes and liquid tubes). 3) If the following conditions are satisfied, the effective range is above 130% and below 200%: A. Obey the limited number of connectable indoor units. B. The lower limit of operating range for heating outdoor temperature is limited to -10°C WB (standard -25°C WB). C. Simultaneous operation is limited to less than 130% of connectable indoor units.



Combination from 42 to 52HP

			42HP	44HP	46HP	48HP	50HP	52HP
Model name			U-10ME2E8	U-12ME2E8	U-14ME2E8	U-16ME2E8	U-10ME2E8	U-12ME2E8
			U-16ME2E8	U-16ME2E8	U-16ME2E8	U-16ME2E8	U-12ME2E8	U-12ME2E8
			U-16ME2E8	U-16ME2E8	U-16ME2E8	U-16ME2E8	U-16ME2E8	U-16ME2E8
Power supply	Voltage	V	380 / 400 / 415	380 / 400 / 415	380 / 400 / 415	380 / 400 / 415	380 / 400 / 415	380 / 400 / 415
	Phase		Three Phase	Three Phase	Three Phase	Three Phase	Three Phase	Three Phase
	Frequency	Hz	50	50	50	50	50	50
Cooling capacity		kW	118,00	124,00	130,00	135,00	140,00	145,00
EER <sup>1)</sup>		W/W	3,69	3,62	3,62	3,52	3,87	3,82
Running current cooling		A	50,20 / 48,40	53,20 / 51,30	56,90 / 54,90	60,20 / 58,10	56,20 / 54,20	59,00 / 56,80
Input power cooling		kW	32,00	34,30	35,90	38,40	36,20	38,00
Heating capacity		kW	132,00	138,00	145,00	150,00	155,00	160,00
COP <sup>1)</sup>		W/W	4,49	4,50	4,46	4,42	4,65	4,66
Running current heating		A	46,60 / 44,90	48,20 / 46,40	51,50 / 49,70	53,80 / 51,80	52,20 / 50,40	53,80 / 51,90
Input power heating		kW	29,40	30,70	32,50	33,90	33,30	34,30
Starting current		A	5,00	5,00	6,00	6,00	5,00	5,00
External static pressure (Max)		Pa	80	80	80	80	80	80
Air volume		m <sup>3</sup> /min	688	696	696	696	920	928
Sound pressure	Normal / Silent mode	dB(A)	65,00 / 62,00	65,50 / 62,50	65,50 / 62,50	66,00 / 63,00	65,50 / 62,50	66,00 / 63,00
Sound power	Normal mode	dB	86,00	86,50	86,50	87,00	86,50	87,00
Dimension / Net weight	HxWxD	mm / kg	1842x3250 x1000/840	1842x3660 x1000/900	1842x3660 x1000/945	1842x3660 x1000/945	1842x4490 x1000/1065	1842x4900 x1000/1125
Piping connections <sup>2)</sup>	Liquid pipe	Inch (mm)	3/4 (19,05) / 7/8 (22,22)	3/4 (19,05) / 7/8 (22,22)	3/4 (19,05) / 7/8 (22,22)	3/4 (19,05) / 7/8 (22,22)	3/4 (19,05) / 7/8 (22,22)	3/4 (19,05) / 7/8 (22,22)
	Gas pipe	Inch (mm)	1-1/2 (38,10) / 1-5/8 (41,28)	1-1/2 (38,10) / 1-5/8 (41,28)	1-1/2 (38,10) / 1-5/8 (41,28)	1-1/2 (38,10) / 1-5/8 (41,28)	1-1/2 (38,10) / 1-5/8 (41,28)	1-1/2 (38,10) / 1-5/8 (41,28)
	Balance pipe	Inch (mm)	1/4 (6,35)	1/4 (6,35)	1/4 (6,35)	1/4 (6,35)	1/4 (6,35)	1/4 (6,35)
Refrigerant (R410A)		kg / TCO <sub>2</sub> Eq.	22,20 / 51,9912	24,90 / 51,9912	24,90 / 51,9912	24,90 / 51,9912	30,50 / 63,6840	33,20 / 69,3216
Maximum allowable indoor / outdoor capacity ratio % <sup>3)</sup>			50 ~ 130 (200)	50 ~ 130 (200)	50 ~ 130 (200)	50 ~ 130 (200)	50 ~ 130 (200)	50 ~ 130 (200)
Operating range	Cool / Heat Min ~ Max	°C	-10 ~ +52 / -25 ~ +18	-10 ~ +52 / -25 ~ +18	-10 ~ +52 / -25 ~ +18	-10 ~ +52 / -25 ~ +18	-10 ~ +52 / -25 ~ +18	-10 ~ +52 / -25 ~ +18

Combination from 54 to 64HP

			54HP	56HP	58HP	60HP	62HP	64HP
Model name			U-10ME2E8	U-12ME2E8	U-10ME2E8	U-12ME2E8	U-14ME2E8	U-16ME2E8
			U-12ME2E8	U-12ME2E8	U-16ME2E8	U-16ME2E8	U-16ME2E8	U-16ME2E8
			U-16ME2E8	U-16ME2E8	U-16ME2E8	U-16ME2E8	U-16ME2E8	U-16ME2E8
			U-16ME2E8	U-16ME2E8	U-16ME2E8	U-16ME2E8	U-16ME2E8	U-16ME2E8
Power supply	Voltage	V	380 / 400 / 415	380 / 400 / 415	380 / 400 / 415	380 / 400 / 415	380 / 400 / 415	380 / 400 / 415
	Phase		Three Phase	Three Phase	Three Phase	Three Phase	Three Phase	Three Phase
	Frequency	Hz	50	50	50	50	50	50
Cooling capacity		kW	151,00	156,00	162,00	168,00	174,00	180,00
EER <sup>1)</sup>		W/W	3,75	3,71	3,65	3,60	3,60	3,52
Running current cooling		A	63,20 / 60,90	65,30 / 63,00	69,70 / 67,10	73,30 / 70,60	75,80 / 73,00	80,30 / 77,40
Input power cooling		kW	40,30	42,10	44,40	46,70	48,30	51,20
Heating capacity		kW	169,00	175,00	182,00	189,00	195,00	201,00
COP <sup>1)</sup>		W/W	4,56	4,56	4,47	4,47	4,45	4,42
Running current heating		A	58,80 / 56,70	60,20 / 58,10	64,60 / 62,20	67,10 / 64,70	69,50 / 67,00	72,20 / 69,60
Input power heating		kW	37,10	38,40	40,70	42,30	43,80	45,50
Starting current		A	6,00	6,00	7,00	7,00	8,00	8,00
External static pressure (Max)		Pa	80	80	80	80	80	80
Air volume		m <sup>3</sup> /min	920	928	920	928	928	928
Sound pressure	Normal / Silent mode	dB(A)	66,00 / 63,00	66,50 / 63,50	66,50 / 63,50	67,00 / 64,00	67,00 / 64,00	67,00 / 64,00
Sound power	Normal mode	dB	87,00	87,50	87,50	88,00	88,00	88,00
Dimension / Net weight	HxWxD	mm / kg	1842x4490 x1000/1110	1842x4900 x1000/1170	1842x4490 x1000/1155	1842x4900 x1000/1215	1842x4900 x1000/1260	1842x4900 x1000/1260
Piping connections <sup>2)</sup>	Liquid pipe	Inch (mm)	3/4 (19,05) / 7/8 (22,22)	3/4 (19,05) / 7/8 (22,22)	3/4 (19,05) / 7/8 (22,22)	3/4 (19,05) / 7/8 (22,22)	3/4 (19,05) / 7/8 (22,22)	3/4 (19,05) / 7/8 (22,22)
	Gas pipe	Inch (mm)	1-1/2 (38,10) / 1-5/8 (41,28)	1-1/2 (38,10) / 1-5/8 (41,28)	1-1/2 (38,10) / 1-5/8 (41,28)	1-1/2 (38,10) / 1-5/8 (41,28)	1-5/8 (41,28) / 1-3/4 (44,45)	1-5/8 (41,28) / 1-3/4 (44,45)
	Balance pipe	Inch (mm)	1/4 (6,35)	1/4 (6,35)	1/4 (6,35)	1/4 (6,35)	1/4 (6,35)	1/4 (6,35)
Refrigerant (R410A)		kg / TCO <sub>2</sub> Eq.	30,50 / 63,6840	33,20 / 69,3216	30,50 / 63,6840	33,20 / 69,3216	33,20 / 69,3216	33,20 / 69,3216
Maximum allowable indoor / outdoor capacity ratio % <sup>3)</sup>			50 ~ 130 (200)	50 ~ 130 (200)	50 ~ 130 (200)	50 ~ 130 (200)	50 ~ 130 (200)	50 ~ 130 (200)
Operating range	Cool / Heat Min ~ Max	°C	-10 ~ +52 / -25 ~ +18	-10 ~ +52 / -25 ~ +18	-10 ~ +52 / -25 ~ +18	-10 ~ +52 / -25 ~ +18	-10 ~ +52 / -25 ~ +18	-10 ~ +52 / -25 ~ +18

Data is for reference. 1) EER and COP calculation is based in accordance to EN14511. 2) Pipe diameter under 90m for ultimate indoor unit / over 90m for ultimate indoor unit (if the longest piping equivalent length exceeds 90m, increase the sizes of the main tubes by 1 rank for gas tubes and liquid tubes). 3) If the following conditions are satisfied, the effective range is above 130% and below 200%: A. Obey the limited number of connectable indoor units. B. The lower limit of operating range for heating outdoor temperature is limited to -10°C WB (standard -25°C WB). C. Simultaneous operation is limited to less than 130% of connectable indoor units.

## 2-PIPE ECOi EX ME2 SERIES SPACE SAVING MODEL COMBINATION FROM 22 TO 80HP

### Combination from 22 to 34HP

			22HP	24HP	26HP	28HP	30HP	32HP	34HP
Model name			U-10ME2E8 U-12ME2E8	U-12ME2E8 U-12ME2E8	U-10ME2E8 U-16ME2E8	U-12ME2E8 U-16ME2E8	U-14ME2E8 U-16ME2E8	U-16ME2E8 U-16ME2E8	U-14ME2E8 U-20ME2E8
Power supply	Voltage	V	380/400/415	380/400/415	380/400/415	380/400/415	380/400/415	380/400/415	380/400/415
	Phase		Three Phase	Three Phase	Three Phase	Three Phase	Three Phase	Three Phase	Three Phase
	Frequency	Hz	50	50	50	50	50	50	50
Cooling capacity		kW	61,50	68,00	73,00	78,50	85,00	90,00	96,00
EER <sup>1)</sup>		W/W	4,13	3,93	3,80	3,69	3,68	3,52	3,56
Running current cooling		A	23,10/22,30	26,60/25,60	30,10/29,00	33,10/31,90	36,60/35,30	40,20/38,70	41,90/40,40
Input power cooling		kW	14,90	17,30	19,20	21,30	23,10	25,60	27,00
Heating capacity		kW	69,00	76,50	81,50	87,50	95,00	100,00	108,00
COP <sup>1)</sup>		W/W	4,76	4,69	4,55	4,56	4,48	4,42	4,17
Running current heating		A	22,70/21,90	25,30/24,40	28,40/27,40	30,10/29,00	33,60/32,40	35,80/34,60	40,60/39,20
Input power heating		kW	14,50	16,30	17,90	19,20	21,20	22,60	25,90
Starting current		A	2,00	2,00	3,00	3,00	4,00	4,00	4,00
External static pressure (Max)		Pa	80	80	80	80	80	80	80
Air volume		m <sup>3</sup> /min	456	464	456	464	464	464	637
Sound pressure	Normal / Silent mode	dB(A)	61,00/58,00	62,00/59,00	62,50/59,50	63,50/60,50	63,50/60,50	64,00/61,00	63,00/60,00
Sound power	Normal mode	dB	82,00	83,00	83,50	84,50	84,50	85,00	84,00
Dimension / Net weight	HxWxD	mm / kg	1842x2010 x1000/480	1842x2420 x1000/540	1842x2010 x1000/525	1842x2420 x1000/585	1842x2420 x1000/630	1842x2420 x1000/630	1842x2780 x1000/690
Piping connections <sup>2)</sup>	Liquid pipe	Inch (mm)	5/8(15,88) / 3/4(19,05)	5/8(15,88) / 3/4(19,05)	3/4(19,05) / 7/8(22,22)	3/4(19,05) / 7/8(22,22)	3/4(19,05) / 7/8(22,22)	3/4(19,05) / 7/8(22,22)	3/4(19,05) / 7/8(22,22)
	Gas pipe	Inch (mm)	1-1/8(28,58) / 1-1/4(31,75)	1-1/8(28,58) / 1-1/4(31,75)	1-1/4(31,75) / 1-1/2(38,10)	1-1/4(31,75) / 1-1/2(38,10)	1-1/4(31,75) / 1-1/2(38,10)	1-1/4(31,75) / 1-1/2(38,10)	1-1/4(31,75) / 1-1/2(38,10)
	Balance pipe	Inch (mm)	1/4(6,35)	1/4(6,35)	1/4(6,35)	1/4(6,35)	1/4(6,35)	1/4(6,35)	1/4(6,35)
Refrigerant (R410A)		kg/TCO <sub>2</sub> Eq.	13,90/23,3856	16,60/34,6608	13,90/29,0232	16,60/34,6608	16,60/34,6608	16,60/34,6608	17,80/37,1664
Maximum allowable indoor / outdoor capacity ratio % <sup>3)</sup>			50 ~ 130(200)	50 ~ 130(200)	50 ~ 130(200)	50 ~ 130(200)	50 ~ 130(200)	50 ~ 130(200)	50 ~ 130(200)
Operating range	Cool Min ~ Max	°C	-10 ~ +52	-10 ~ +52	-10 ~ +52	-10 ~ +52	-10 ~ +52	-10 ~ +52	-10 ~ +52
	Heat Min ~ Max	°C	-25 ~ +18	-25 ~ +18	-25 ~ +18	-25 ~ +18	-25 ~ +18	-25 ~ +18	-25 ~ +18

### Combination from 36 to 48HP

			36HP	38HP	40HP	42HP	44HP	46HP	48HP
Model name			U-16ME2E8 U-20ME2E8	U-18ME2E8 U-20ME2E8	U-20ME2E8 U-20ME2E8	U-10ME2E8 U-16ME2E8 U-16ME2E8	U-12ME2E8 U-16ME2E8 U-16ME2E8	U-14ME2E8 U-16ME2E8 U-16ME2E8	U-16ME2E8 U-16ME2E8
Power supply	Voltage	V	380/400/415	380/400/415	380/400/415	380/400/415	380/400/415	380/400/415	380/400/415
	Phase		Three Phase	Three Phase	Three Phase	Three Phase	Three Phase	Three Phase	Three Phase
	Frequency	Hz	50	50	50	50	50	50	50
Cooling capacity		kW	101,00	107,00	113,00	118,00	124,00	130,00	135,00
EER <sup>1)</sup>		W/W	3,42	3,42	3,34	3,69	3,62	3,62	3,52
Running current cooling		A	45,30/43,70	48,10/46,30	51,40/49,50	50,20/48,40	53,20/51,30	56,90/54,90	60,20/58,10
Input power cooling		kW	25,9	31,3	33,8	32,0	34,3	35,9	38,4
Heating capacity		kW	113,00	119,00	127,00	132,00	138,00	145,00	150,00
COP <sup>1)</sup>		W/W	4,14	4,13	3,92	4,49	4,50	4,46	4,42
Running current heating		A	42,40/40,80	44,70/43,10	49,80/48,00	46,60/44,90	48,20/46,40	51,50/49,70	53,80/51,80
Input power heating		kW	27,30	28,80	32,40	29,40	30,70	32,50	33,90
Starting current		A	4,00	4,00	4,00	5,00	5,00	6,00	6,00
External static pressure (Max)		Pa	80	80	80	80	80	80	80
Air volume		m <sup>3</sup> /min	637	810	810	688	696	696	696
Sound pressure	Normal / Silent mode	dB(A)	63,50/60,50	62,50/59,50	63,00/60,00	65,00/62,00	65,50/62,50	65,50/62,50	66,00/63,00
Sound power	Normal mode	dB	84,50	83,50	84,00	86,00	86,50	86,50	87,00
Dimension / Net weight	HxWxD	mm / kg	1842x2780 x1000/690	1842x3140 x1000/750	1842x3140 x1000/750	1842x3250 x1000/840	1842x3660 x1000/900	1842x3660 x1000/945	1842x3660 x1000/945
Piping connections <sup>2)</sup>	Liquid pipe	Inch (mm)	3/4(19,05) / 7/8(22,22)	3/4(19,05) / 7/8(22,22)	3/4(19,05) / 7/8(22,22)	3/4(19,05) / 7/8(22,22)	3/4(19,05) / 7/8(22,22)	3/4(19,05) / 7/8(22,22)	3/4(19,05) / 7/8(22,22)
	Gas pipe	Inch (mm)	1-1/2(38,10) / 1-5/8(41,28)	1-1/2(38,10) / 1-5/8(41,28)	1-1/2(38,10) / 1-5/8(41,28)	1-1/2(38,10) / 1-5/8(41,28)	1-1/2(38,10) / 1-5/8(41,28)	1-1/2(38,10) / 1-5/8(41,28)	1-1/2(38,10) / 1-5/8(41,28)
	Balance pipe	Inch (mm)	1/4(6,35)	1/4(6,35)	1/4(6,35)	1/4(6,35)	1/4(6,35)	1/4(6,35)	1/4(6,35)
Refrigerant (R410A)		kg/TCO <sub>2</sub> Eq.	17,80/37,1664	19,00/39,672	19,00/39,672	22,20/46,3536	24,90/51,9912	24,90/51,9912	24,90/51,9912
Maximum allowable indoor / outdoor capacity ratio % <sup>3)</sup>			50 ~ 130(200)	50 ~ 130(200)	50 ~ 130(200)	50 ~ 130(200)	50 ~ 130(200)	50 ~ 130(200)	50 ~ 130(200)
Operating range	Cool Min ~ Max	°C	-10 ~ +52	-10 ~ +52	-10 ~ +52	-10 ~ +52	-10 ~ +52	-10 ~ +52	-10 ~ +52
	Heat Min ~ Max	°C	-25 ~ +18	-25 ~ +18	-25 ~ +18	-25 ~ +18	-25 ~ +18	-25 ~ +18	-25 ~ +18

1) EER and COP calculation is based in accordance to EN14511. 2) Pipe diameter under 90m for ultimate indoor unit / over 90m for ultimate indoor unit (if the longest piping equivalent length exceeds 90m, increase the sizes of the main tubes by 1 rank for gas tubes and liquid tubes). 3) If the following conditions are satisfied, the effective range is above 130% and below 200%: A. Obey the limited number of connectable indoor units. B. The lower limit of operating range for heating outdoor temperature is limited to -10°C WB (standard -25°C WB). C. Simultaneous operation is limited to less than 130% of connectable indoor units.





Combination from 50 to 64HP

			50HP	52HP	54HP	56HP	58HP	60HP	62HP	64HP
Model name			U-14ME2E8	U-16ME2E8	U-14ME2E8	U-16ME2E8	U-18ME2E8	U-20ME2E8	U-14ME2E8	U-16ME2E8
			U-16ME2E8	U-16ME2E8	U-20ME2E8	U-20ME2E8	U-20ME2E8	U-20ME2E8	U-16ME2E8	U-16ME2E8
			U-20ME2E8	U-20ME2E8	U-20ME2E8	U-20ME2E8	U-20ME2E8	U-20ME2E8	U-16ME2E8	U-16ME2E8
Power supply	Voltage	V	380 / 400 / 415	380 / 400 / 415	380 / 400 / 415	380 / 400 / 415	380 / 400 / 415	380 / 400 / 415	380 / 400 / 415	380 / 400 / 415
	Phase		Three Phase	Three Phase	Three Phase	Three Phase	Three Phase	Three Phase	Three Phase	Three Phase
	Frequency	Hz	50	50	50	50	50	50	50	50
Cooling capacity			140,00	145,00	151,00	156,00	162,00	168,00	174,00	180,00
EER <sup>1)</sup>			3,55	3,46	3,49	3,41	3,40	3,35	3,60	3,52
Running current cooling			61,10 / 58,90	65,00 / 62,70	66,50 / 64,10	70,30 / 67,80	73,10 / 70,40	76,10 / 73,40	75,80 / 73,00	80,30 / 77,40
Input power cooling			39,40	41,90	43,30	45,80	47,60	50,10	48,30	51,20
Heating capacity			155,00	160,00	169,00	175,00	182,00	189,00	195,00	201,00
COP <sup>1)</sup>			4,29	4,27	4,11	4,08	4,06	3,94	4,45	4,42
Running current heating			56,60 / 54,60	58,80 / 56,70	63,80 / 61,50	66,60 / 64,20	69,50 / 67,00	73,70 / 71,00	69,50 / 67,00	72,20 / 69,60
Input power heating			36,10	37,50	41,10	42,90	44,80	48,00	43,80	45,50
Starting current			6,00	6,00	6,00	6,00	6,00	6,00	8,00	8,00
External static pressure (Max)			80	80	80	80	80	80	80	80
Air volume			869	869	1042	1042	1215	1215	928	928
Sound pressure	Normal / Silent mode	dB(A)	65,50 / 62,50	65,50 / 62,50	65,00 / 62,00	65,50 / 62,50	64,50 / 61,50	65,00 / 62,00	67,00 / 64,00	67,00 / 64,00
Sound power	Normal mode	dB	86,50	86,50	86,00	86,50	85,50	86,00	88,00	88,00
Dimension / Net weight	HxWxD	mm / kg	1842 x 4020 x 1000 / 1005	1842 x 4020 x 1000 / 1005	1842 x 4380 x 1000 / 1065	1842 x 4380 x 1000 / 1065	1842 x 4740 x 1000 / 1125	1842 x 4740 x 1000 / 1125	1842 x 4900 x 1000 / 1260	1842 x 4900 x 1000 / 1260
Piping connections <sup>2)</sup>	Liquid pipe	Inch (mm)	3/4 (19,05) / 7/8 (22,22)	3/4 (19,05) / 7/8 (22,22)	3/4 (19,05) / 7/8 (22,22)	3/4 (19,05) / 7/8 (22,22)	3/4 (19,05) / 7/8 (22,22)	3/4 (19,05) / 7/8 (22,22)	3/4 (19,05) / 7/8 (22,22)	3/4 (19,05) / 7/8 (22,22)
	Gas pipe	Inch (mm)	1-1/2 (38,10) / 1-5/8 (41,28)	1-1/2 (38,10) / 1-5/8 (41,28)	1-1/2 (38,10) / 1-5/8 (41,28)	1-1/2 (38,10) / 1-5/8 (41,28)	1-1/2 (38,10) / 1-5/8 (41,28)	1-1/2 (38,10) / 1-5/8 (41,28)	1-5/8 (41,28) / 1-3/4 (44,45)	1-5/8 (41,28) / 1-3/4 (44,45)
	Balance pipe	Inch (mm)	1/4 (6,35)	1/4 (6,35)	1/4 (6,35)	1/4 (6,35)	1/4 (6,35)	1/4 (6,35)	1/4 (6,35)	1/4 (6,35)
Refrigerant (R410A)			26,10 / 54,4968	26,10 / 54,4968	27,30 / 57,0024	27,30 / 57,0024	28,50 / 59,508	28,50 / 59,508	33,20 / 69,3216	33,20 / 69,3216
Maximum allowable indoor / outdoor capacity ratio % <sup>3)</sup>			50 ~ 130 (200)	50 ~ 130 (200)	50 ~ 130 (200)	50 ~ 130 (200)	50 ~ 130 (200)	50 ~ 130 (200)	50 ~ 130 (200)	50 ~ 130 (200)
Operating range	Cool Min ~ Max	°C	-10 ~ +52	-10 ~ +52	-10 ~ +52	-10 ~ +52	-10 ~ +52	-10 ~ +52	-10 ~ +52	-10 ~ +52
	Heat Min ~ Max	°C	-25 ~ +18	-25 ~ +18	-25 ~ +18	-25 ~ +18	-25 ~ +18	-25 ~ +18	-25 ~ +18	-25 ~ +18

Combination from 66 to 80HP

			66HP	68HP	70HP	72HP	74HP	76HP	78HP	80HP
Model name			U-10ME2E8	U-12ME2E8	U-10ME2E8	U-16ME2E8	U-16ME2E8	U-16ME2E8	U-18ME2E8	U-20ME2E8
			U-16ME2E8	U-16ME2E8	U-20ME2E8	U-16ME2E8	U-18ME2E8	U-20ME2E8	U-20ME2E8	U-20ME2E8
			U-20ME2E8	U-20ME2E8	U-20ME2E8	U-20ME2E8	U-20ME2E8	U-20ME2E8	U-20ME2E8	U-20ME2E8
			U-20ME2E8	U-20ME2E8	U-20ME2E8	U-20ME2E8	U-20ME2E8	U-20ME2E8	U-20ME2E8	U-20ME2E8
Power supply	Voltage	V	380 / 400 / 415	380 / 400 / 415	380 / 400 / 415	380 / 400 / 415	380 / 400 / 415	380 / 400 / 415	380 / 400 / 415	380 / 400 / 415
	Phase		Three Phase	Three Phase	Three Phase	Three Phase	Three Phase	Three Phase	Three Phase	Three Phase
	Frequency	Hz	50	50	50	50	50	50	50	50
Cooling capacity			185,00	190,00	196,00	202,00	208,00	213,00	219,00	224,00
EER <sup>1)</sup>			3,52	3,49	3,47	3,42	3,42	3,39	3,38	3,35
Running current cooling			80,80 / 77,80	83,70 / 80,70	86,80 / 83,60	90,60 / 87,30	93,40 / 90,00	96,60 / 93,10	98,30 / 94,70	101,50 / 97,80
Input power cooling			52,60	54,50	56,50	59,00	60,80	62,90	64,70	66,80
Heating capacity			207,00	213,00	219,00	226,00	233,00	239,00	245,00	252,00
COP <sup>1)</sup>			4,16	4,18	4,05	4,14	4,12	4,03	4,03	3,94
Running current heating			77,10 / 74,30	79,20 / 76,30	83,10 / 80,10	84,70 / 81,70	87,70 / 84,50	92,00 / 88,70	93,40 / 90,00	98,30 / 94,70
Input power heating			49,70	51,00	54,10	54,60	56,50	59,30	60,80	64,00
Starting current			7,00	7,00	7,00	8,00	8,00	8,00	8,00	8,00
External static pressure (Max)			80	80	80	80	80	80	80	80
Air volume			1266	1274	1439	1274	1447	1447	1620	1620
Sound pressure	Normal / Silent mode	dB(A)	66,00 / 63,00	66,50 / 63,50	65,50 / 62,50	66,50 / 63,50	66,50 / 63,50	66,50 / 63,50	66,00 / 63,00	66,00 / 63,00
Sound power	Normal mode	dB	87,00	87,50	86,50	87,50	87,50	87,50	87,00	87,00
Dimension / Net weight	HxWxD	mm / kg	1842 x 5210 x 1000 / 1275	1842 x 5620 x 1000 / 1335	1842 x 5570 x 1000 / 1335	1842 x 5620 x 1000 / 1380	1842 x 5980 x 1000 / 1440	1842 x 5980 x 1000 / 1440	1842 x 6340 x 1000 / 1500	1842 x 6340 x 1000 / 1500
Piping connections <sup>2)</sup>	Liquid pipe	Inch (mm)	3/4 (19,05) / 7/8 (22,22)	7/8 (22,22) / 1 (25,04)	7/8 (22,22) / 1 (25,04)	7/8 (22,22) / 1 (25,04)	7/8 (22,22) / 1 (25,04)	7/8 (22,22) / 1 (25,04)	7/8 (22,22) / 1 (25,04)	7/8 (22,22) / 1 (25,04)
	Gas pipe	Inch (mm)	1-5/8 (41,28) / 1-3/4 (44,45)	1-5/8 (41,28) / 1-3/4 (44,45)	1-5/8 (41,28) / 1-3/4 (44,45)	1-3/4 (44,45) / 2 (50,80)	1-3/4 (44,45) / 2 (50,80)	1-3/4 (44,45) / 2 (50,80)	1-3/4 (44,45) / 2 (50,80)	1-3/4 (44,45) / 2 (50,80)
	Balance pipe	Inch (mm)	1/4 (6,35)	1/4 (6,35)	1/4 (6,35)	1/4 (6,35)	1/4 (6,35)	1/4 (6,35)	1/4 (6,35)	1/4 (6,35)
Refrigerant (R410A)			32,90 / 68,6952	35,60 / 74,3328	34,10 / 19,836	35,80 / 68,6952	36,80 / 19,836	36,80 / 76,8384	38,00 / 79,344	38,00 / 79,344
Maximum allowable indoor / outdoor capacity ratio % <sup>3)</sup>			50 ~ 130 (200)	50 ~ 130 (200)	50 ~ 130 (200)	50 ~ 130 (200)	50 ~ 130 (200)	50 ~ 130 (200)	50 ~ 130 (200)	50 ~ 130 (200)
Operating range	Cool Min ~ Max	°C	-10 ~ +52	-10 ~ +52	-10 ~ +52	-10 ~ +52	-10 ~ +52	-10 ~ +52	-10 ~ +52	-10 ~ +52
	Heat Min ~ Max	°C	-25 ~ +18	-25 ~ +18	-25 ~ +18	-25 ~ +18	-25 ~ +18	-25 ~ +18	-25 ~ +18	-25 ~ +18

1) EER and COP calculation is based in accordance to EN14511. 2) Pipe diameter under 90m for ultimate indoor unit / over 90m for ultimate indoor unit (if the longest piping equivalent length exceeds 90m, increase the sizes of the main tubes by 1 rank for gas tubes and liquid tubes). 3) If the following conditions are satisfied, the effective range is above 130% and below 200%: A. Obey the limited number of connectable indoor units. B. The lower limit of operating range for heating outdoor temperature is limited to -10°C WB (standard -25°C WB). C. Simultaneous operation is limited to less than 130% of connectable indoor units.

# 3-PIPE ECOi MF2 6N SERIES



## Simultaneous heating and cooling VRF system. The Panasonic 3-Pipe MF2 Series offers the best solution for the most demanding customers.

- The 3-Pipe units have only one chassis size, with a very small footprint (only 0,93m<sup>2</sup>)
- 1 body for all sizes: 1.758 x 1.000 x 930mm, for 8, 10, 12, 14 and 16HP

- Maximum capacity size as 48HP by 3 unit combinations
- Up to 52 indoor units connectable
- Connectable indoor/outdoor unit capacity ratio up to 150%

### Market-leading COP (at full load), High Efficiency Combination.

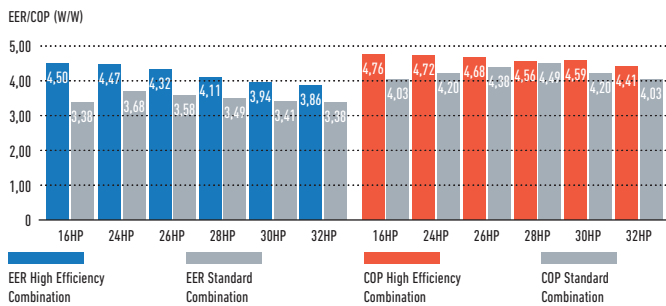

### Market-leading COP (at full load), standard efficiency.

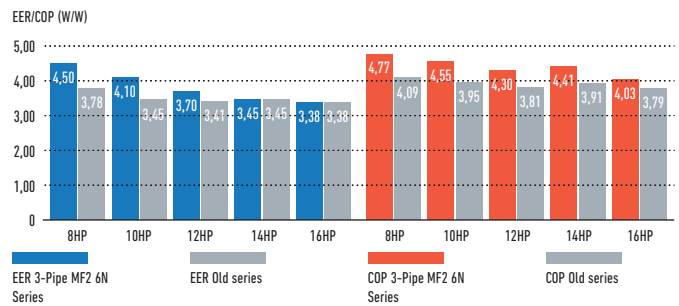

## SEER and SCOP values

ECOi models have superior seasonal space cooling/heating efficiency following not only EN 14825 but also COMMISSION REGULATION (EU) 2016/2281. This regulation requires to use "η" values in the technical documents from January 2018.

Please visit our websites [www.aircon.panasonic.eu](http://www.aircon.panasonic.eu) or [www.ptc.panasonic.eu](http://www.ptc.panasonic.eu).

### SEER/SCOP (W/W)

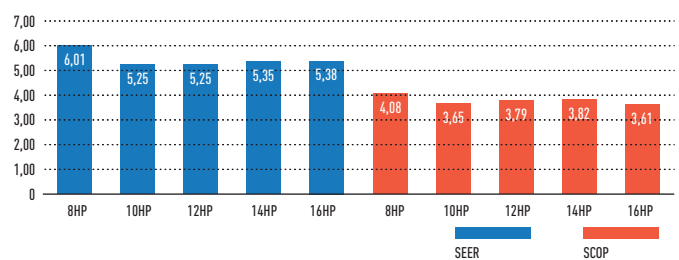

## 3-Pipe Control Box Kit / Multiple connection type

New Heat Recovery Box to connect multiple indoor units with just one box, 4, 6 and up to 8 indoor units or groups. This is good advantage specially in hotel applications, where space for connecting several boxes is limited.

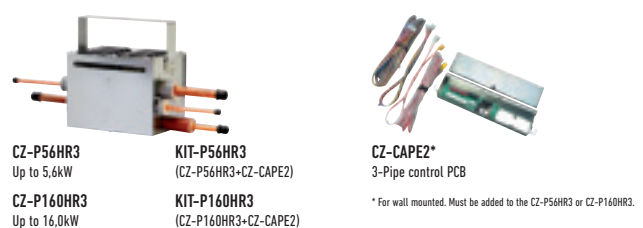
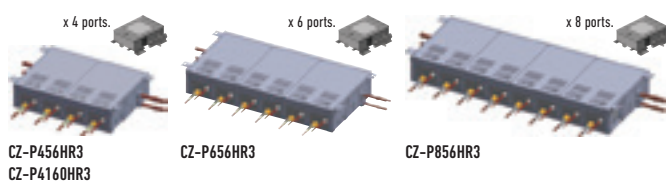

## Individual control of multiple indoor units with solenoid valve kits.

- Any design and layout can be used in a single system.
- Cooling operation is possible up to an outdoor temperature of -10°C.

### System structure.

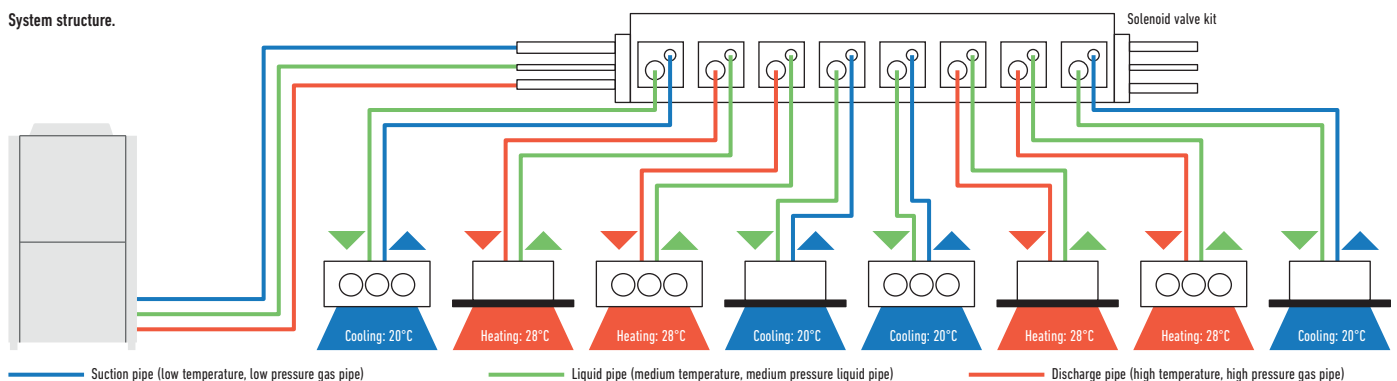

# 3-PIPE ECOi MF2 6N SERIES

## Extended design operation conditions

Cooling design operation conditions: The cooling operation range has been extended to -10°C by changing the outdoor fan to an inverter type.

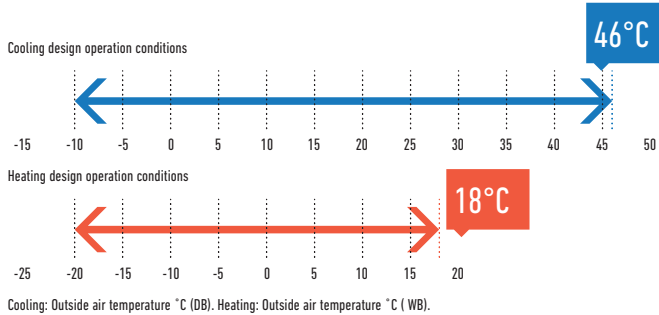

Heating design operation conditions: Stable heating operation even with an outside air temperature of -20°C. The heating operation range has been extended to -20°C by use of a compressor with a high-pressure vessel.

## Wide temperature setting range.

Wired remote control heating temperature setting range is 16 to 30°C.

## Large combination of outdoor units, up to 48HP

Unit	System ( HP )																					
	8	10	12	14	16	18	20	22	24	26	28	30	32	34	36	38	40	42	44	46	48	
8	1				1	1	1	1						1	1	1	1					
10		1			1									1								
12			1			1				1				1								
14				1			1		1	2	1		1	2	1		3	2	1			
16					1			1			1	2			1	2		1	2	3		

## High efficiency combination.

Unit	System ( HP )					
	16	24	26	28	30	32
8	2	3	2	2	2	1
10			1			
12				1		2
14					1	

## Power suppression control for energy saving (Demand control)<sup>1</sup>

The 3-Pipe ECOi MF2 6N Series has a built-in demand function which uses the inverter characteristics. With this demand function, the power consumption can be set in three steps, and operation<sup>2</sup> at optimum performance is performed according to the setting and the power consumption. This function is useful to reduce the annual power consumption and to save electricity costs while maintaining comfort.

<sup>1</sup> An outdoor Seri-Para I/O unit is required for demand input.  
<sup>2</sup> Setting is possible as 0% or in the range from 40 to 100% (in steps of 5%). At the time of shipping, setting has been done to the three steps of 0%, 70%, and 100%.

## Non-stop operation during maintenance

Even when an indoor unit needs maintenance, the other indoor units can be kept operating by setting. (Not applicable for all situations)

## Compact design for superb space saving and low noise level

5 types of outdoor units with different capacities have been standardized to one compact casing.

Uniquely constructed with two compartments, the upper chamber contains the heat exchange, with the lower chamber stores the compressors. The benefits are two-fold - superb space saving and low noise level.

Installation space: 0.93m<sup>2</sup>.

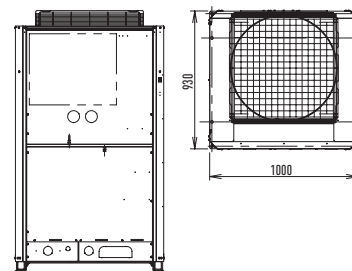

Operating sound dB(A).

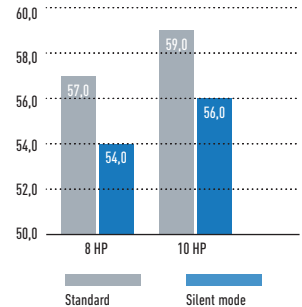

## Increased piping lengths and design flexibility

Adaptable to various building types and sizes. Actual piping length: 180m. Maximum piping length: 500m.

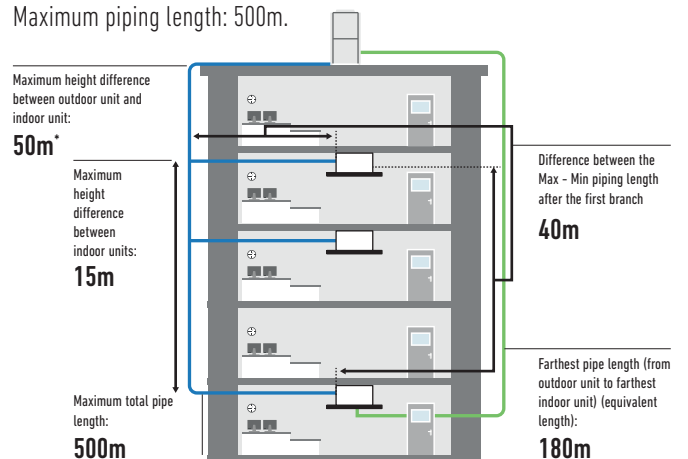

\* 40m if the outdoor unit is below the indoor unit.

Additional refrigerant charge (g/m)							
Liquid piping size	6,35	9,52	12,70	15,88	19,05	22,22	25,40
Amount of refrigerant charge	26	56	128	185	259	366	490
Refrigerant piping (Piping size (mm))							
0 material	Outer diameter	6,35	9,52	12,70	15,88	19,05	22,22
	Wall thickness	0,80	0,80	1,00	1,00	1,15	
1/2 H, H material	Outer diameter	25,40	28,58	31,75	38,10	41,28	
	Wall thickness	1,00	1,00	1,10	over 1,35	over 1,45	

Note: When pipe bending is to be performed, the bending radius shall be at least 4 times the outer diameter. Also, take sufficient care to prevent pipe collapse and damage at the time of bending.

### Excellent cost saving and smaller piping size

By using R410A with low pressure loss, pipe sizes for discharge, suction and liquid are all reduced. This makes it possible to aim for reduced piping space, improved workability at the site, and reduction of the piping material costs.

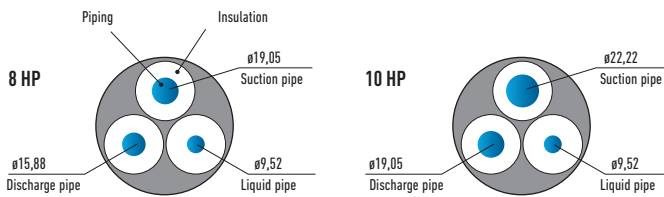

### 3-Pipe wind protection shield

PAW-WPH1	1 long side of the outdoor unit (624 x 983 x 489)
PAW-WPH2	1 long side of the outdoor units (853 x 983 x 489)
PAW-WPH3	2 long sides of the outdoor units (744 x 983 x 289) (2ER SET)

### Extended compressor life by uniform compressor operation time

The total run-time of compressors are monitored by a built-in microcomputer, which ensures that operation times of all compressors within the same refrigerant circuit are balanced. Compressors with histories showing shorter run times are selected first, ensuring equal wear and tear across all units and extended the working life of the system.

#### System example.

A,C: DC inverter compressor  
B,D: Constant speed compressor

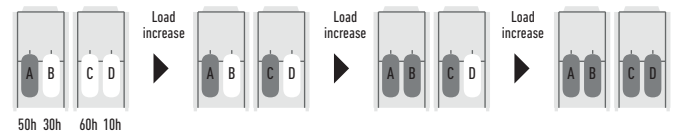

\* Depend on accumulated operation time of each compressors.  
\* Compressor priority has possibility to be changed.  
(e.g) Case 1: A→C→B→D, Case 2: C→A→D→B, Case 3: A→C→D→B, Case 4: C→A→B→D  
\* Also other cases available.

### Piping design

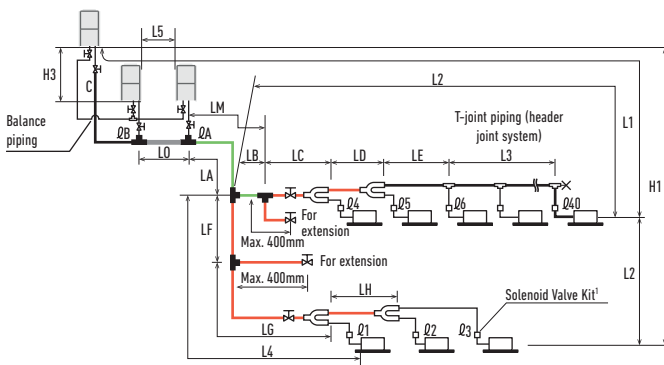

- Main piping length LM = LA + LB--
- Main distribution pipes LC-LH are selected according to the capacity after the distribution joint.
- Size of indoor unit connection piping 1-40 is determined by the connection piping size on the indoor units.
- ◀ Distribution joint (CZ, option).
- ⊙ Ball valve (BV, option)
- ⊕ T-joint (field supply)
- × Solidly welded shut (pinch weld)

The outdoor connection main piping (LO portion) is determined by the total capacity of the outdoor units that are connected to the tube end.  
Note: Do not use commercial T-pieces for the liquid pipes of the distribution joint.

**R410A distribution joint**  
CZ-P680PH2 (for outdoor unit)  
CZ-P1350PH2 (for outdoor unit)  
CZ-P224HK2 (for indoor unit)  
CZ-P680HK2 (for indoor unit)  
CZ-P1350HK2 (for indoor unit)

### Ranges that apply to refrigerant piping lengths and to differences in installation heights

Items	Marks	Contents	Length (m)
Allowable piping length	L1	Maximum piping length	Actual piping length
			Equivalent piping length
	Δ L (L2-L4)	Difference between the Maximum length and the minimum length from the No. 1 distribution	≤40
	LM	Maximum length of main piping (at Maximum diameter)	— <sup>2</sup>
	Δ1, Δ2-Δ40	Maximum length of each distribution	≤30
Allowable elevation difference	L1+Δ1+Δ2...Δ39+ΔA+ΔB+LF+LG+LH	Total Maximum piping length including length of each distribution (only liquid piping)	≤500 <sup>3</sup>
	L5	Distance between outdoor units	≤10
	H1	When outdoor unit is installed higher than indoor unit	≤50
	H2	When outdoor unit is installed lower than indoor unit	≤40
Allowable length of joint piping	H3	Maximum difference between indoor units	≤15
	H3	Maximum difference between outdoor units	≤4
	L3	T-joint piping (field-supply); Maximum piping length between the first T-joint and solidly welded-shut end point	≤2

L = Length, H = Height

1) If the longest piping length (L1) exceeds 90m (equivalent length), increase the sizes of the main tubes (LM) by 1 rank for the discharge tubes, suction tubes, and narrow tubes (field supplied). 2) If the longest main tube length (LM) exceeds 50m, increase the main tube size at the portion before 50m by 1 rank for the suction tubes and discharge tubes (field supplied). (For the portion that exceeds 50m, set based on the main tube sizes (LA) listed in the table on the following page). 3) 24HP - 30HP of high efficiency combination is 300m.

# 3-PIPE ECOi MF2 6N SERIES HIGH EFFICIENCY COMBINATION FROM 16 TO 32HP



With simultaneous heating and cooling operation heat recovery type.

ECOi 3-Pipe is one of the most advanced VRF systems available. Not only offering high-efficiency and performance for simultaneous heating and cooling, its sophisticated design makes installation and maintenance much easier.

- Achieves COP 4,76 as the top class in the industry (average cooling and heating value for 8HP outdoor unit)
- Simultaneous cooling or heating operation for up to 52 indoor units
- Small installation space, top class in the industry
- Rotation operation function and back-up operation function provided

- Standardisation of outdoor unit to one compact casing size
- Improved operation efficiency
- The constant-speed compressor adopts a high-performance internal high-pressure scroll
- Improvement of the heat exchanger
- Redesign of structural parts
- Close side-by-side installation is possible

## Technical focus

HP			16HP	24HP	26HP	28HP	30HP	32HP
High Efficiency model			U-8MF2E8 U-8MF2E8	U-8MF2E8 U-8MF2E8 U-8MF2E8	U-8MF2E8 U-8MF2E8 U-10MF2E8	U-8MF2E8 U-8MF2E8 U-12MF2E8	U-8MF2E8 U-8MF2E8 U-14MF2E8	U-8MF2E8 U-12MF2E8
Power supply	Voltage	V	380 / 400 / 415	380 / 400 / 415	380 / 400 / 415	380 / 400 / 415	380 / 400 / 415	380 / 400 / 415
	Phase		Three Phase	Three Phase	Three Phase	Three Phase	Three Phase	Three Phase
	Frequency	Hz	50	50	50	50	50	50
Cooling capacity		kW	45,00	68,00	73,00	78,50	85,00	90,00
EER <sup>1)</sup>		W/W	4,50	4,47	4,32	4,11	3,94	3,86
Running current	380V	A	17,30	26,20	28,50	32,20	36,50	38,90
	400V	A	16,40	24,90	27,40	31,00	35,00	37,40
	415V	A	16,00	24,30	26,70	30,20	34,10	36,40
Input power		kW	10,00	15,20	16,90	19,10	21,60	23,30
Heating capacity		kW	50,00	76,50	81,50	87,50	95,00	100,00
COP <sup>1)</sup>		W/W	4,76	4,72	4,68	4,56	4,59	4,41
Running current	380V	A	17,90	27,70	29,40	32,40	35,00	38,30
	400V	A	17,00	26,30	27,90	31,10	33,60	36,80
	415V	A	16,60	25,60	27,50	30,40	32,70	35,90
Input power		kW	10,50	16,20	17,40	19,20	20,70	22,70
Air volume		m <sup>3</sup> /min	316	474	494	528	528	582
Sound pressure	Hi / Lo	dB(A)	60,00 / 57,00	62,00 / 59,00	62,50 / 59,50	63,50 / 60,50	64,00 / 61,00	65,00 / 62,00
Dimension (Combination)	H x W x D	mm	1758 x 2060 x 930	1758 x 3120 x 930	1758 x 3120 x 930	1758 x 3120 x 930	1758 x 3120 x 930	1758 x 3120 x 930
Net weight		kg	538	807	807	852	860	897
Piping connections	Suction pipe	Inch (mm)	1-1/8(28,58)	1-1/8(28,58)	1 1/4(31,75)	1 1/4(31,75)	1 1/4(31,75)	1 1/4(31,75)
	Discharge pipe	Inch (mm)	7/8(22,22)	1(25,40)	1(25,40)	1-1/8(28,58)	1-1/8(28,58)	1-1/8(28,58)
	Liquid pipe	Inch (mm)	1/2(12,70)	5/8(15,88)	3/4(19,05)	3/4(19,05)	3/4(19,05)	3/4(19,05)
	Balance pipe	Inch (mm)	1/4(6,35)	1/4(6,35)	1/4(6,35)	1/4(6,35)	1/4(6,35)	1/4(6,35)
Refrigerant (R410A)		kg / TCO, Eq.	16,60 / 34,6608	24,90 / 51,9912	25,10 / 52,4088	25,40 / 53,0352	25,90 / 54,0792	25,90 / 54,0792
Operating range	Cool Min ~ Max	°C	-10 ~ +46	-10 ~ +46	-10 ~ +46	-10 ~ +46	-10 ~ +46	-10 ~ +46
	Heat Min ~ Max	°C	-20 ~ +18	-20 ~ +18	-20 ~ +18	-20 ~ +18	-20 ~ +18	-20 ~ +18
	Simultaneous op.	°C	-10 ~ +24	-10 ~ +24	-10 ~ +24	-10 ~ +24	-10 ~ +24	-10 ~ +24

### Solenoid valve kit

KIT-P56HR3	KIT-P56HR3	3-Pipe control Solenoid valve kit (up to 5,6kW)
	CZ-P56HR3	Solenoid valve kit (up to 5,6kW)
	CZ-CAPE2	3-Pipe control PCB
KIT-P160HR3	KIT-P160HR3	3-Pipe control Solenoid valve kit (from 5,6 to 10,6kW)
	CZ-P160HR3	Solenoid valve kit (up to 16,0kW)
	CZ-CAPE2	3-Pipe control PCB
CZ-CAPE2		3-Pipe control PCB for wall mounted

### 3-Pipe control box kit

CZ-P456HR3	4 ports 3 pipe box (up to 5,6kW)
CZ-P656HR3	6 ports 3 pipe box (up to 5,6kW)
CZ-P856HR3	8 ports 3 pipe box (up to 5,6kW)
CZ-P4160HR3	4 ports 3 pipe box (up to 16,0kW)

1) EER and COP calculation is based in accordance to EN14511.



## 3-PIPE ECOi MF2 6N SERIES



### With simultaneous heating and cooling operation heat recovery type.

ECOi 3-Pipe is one of the most advanced VRF systems available. Not only offering high-efficiency and performance for simultaneous heating and cooling, but also its sophisticated installation and maintenance much easier.

- Achieves COP 4,77 as the top class in the industry (average cooling and heating value for 8HP outdoor unit)
- Simultaneous cooling or heating operation for up to 26 indoor units
- Small installation space, top class in the industry
- Rotation operation function and back-up operation function provided

- Standardisation of outdoor unit to one compact casing size
- Improved operation efficiency
- The constant-speed compressor adopts a high-performance internal high-pressure scroll
- Improvement of the heat exchanger
- Redesign of structural parts
- Close side-by-side installation is possible

### Technical focus

HP			8HP	10HP	12HP	14HP	16HP
Standard model			U-8MF2E8	U-10MF2E8	U-12MF2E8	U-14MF2E8	U-16MF2E8
Power supply	Voltage	V	380 / 400 / 415	380 / 400 / 415	380 / 400 / 415	380 / 400 / 415	380 / 400 / 415
	Phase		Three Phase	Three Phase	Three Phase	Three Phase	Three Phase
	Frequency	Hz	50	50	50	50	50
Cooling capacity		kW	22,40	28,00	33,50	40,00	45,00
EER <sup>1)</sup>		W/W	4,50	4,10	3,70	3,45	3,38
<b>SEER <sup>2)</sup></b>		<b>W/W</b>	<b>6,08</b>	<b>5,32</b>	<b>5,32</b>	<b>5,43</b>	<b>5,46</b>
Running current	380V	A	8,60	11,30	15,10	19,20	22,00
	400V	A	8,20	10,80	14,50	18,40	21,10
	415V	A	8,00	10,60	14,10	17,90	20,60
Input power		kW	4,98	6,83	9,05	11,00	13,00
Heating capacity		kW	25,00	31,50	37,50	45,00	50,00
COP <sup>1)</sup>		W/W	4,77	4,55	4,30	4,41	4,03
<b>SCOP <sup>2)</sup></b>		<b>W/W</b>	<b>4,16</b>	<b>3,72</b>	<b>3,87</b>	<b>3,89</b>	<b>3,68</b>
Running current	380V	A	8,95	11,60	14,70	17,00	20,70
	400V	A	8,50	11,00	14,10	16,40	19,90
	415V	A	8,30	10,70	13,80	15,90	19,40
Input power		kW	5,240	6,920	8,720	10,20	12,40
Air volume		m <sup>3</sup> /min	158	178	212	212	212
Sound pressure	Hi / Lo	dB(A)	57,00 / 54,00	59,00 / 56,00	61,00 / 58,00	62,00 / 59,00	62,00 / 59,00
Dimension	H x W x D	mm	1758 x 1000 x 930	1758 x 1000 x 930	1758 x 1000 x 930	1758 x 1000 x 930	1758 x 1000 x 930
Net weight		kg	269	269	314	322	322
Piping connections	Suction pipe	Inch (mm)	3/4 (19,05)	7/8 (22,22)	1 (25,40)	1 (25,40)	1-1/8 (28,58)
	Discharge pipe	Inch (mm)	5/8 (15,88)	3/4 (19,05)	3/4 (19,05)	7/8 (22,22)	7/8 (22,22)
	Liquid pipe	Inch (mm)	3/8 (9,52)	3/8 (9,52)	1/2 (12,70)	1/2 (12,70)	1/2 (12,70)
	Balance pipe	Inch (mm)	1/4 (6,35)	1/4 (6,35)	1/4 (6,35)	1/4 (6,35)	1/4 (6,35)
Refrigerant (R410A)		kg / TCO <sub>2</sub> Eq.	8,30 / 17,3304	8,50 / 17,748	8,80 / 18,3744	9,30 / 19,4184	9,30 / 19,4184
Operating range	Cool Min ~ Max	°C	-10 ~ +46	-10 ~ +46	-10 ~ +46	-10 ~ +46	-10 ~ +46
	Heat Min ~ Max	°C	-20 ~ +18	-20 ~ +18	-20 ~ +18	-20 ~ +18	-20 ~ +18
	Simultaneous op.	°C	-10 ~ +24	-10 ~ +24	-10 ~ +24	-10 ~ +24	-10 ~ +24

#### Solenoid valve kit

KIT-P56HR3	KIT-P56HR3	3-Pipe control Solenoid valve kit (up to 5,6kW)
	CZ-P56HR3	Solenoid valve kit (up to 5,6kW)
	CZ-CAPE2	3-Pipe control PCB
KIT-P160HR3	KIT-P160HR3	3-Pipe control Solenoid valve kit (from 5,6 to 10,6kW)
	CZ-P160HR3	Solenoid valve kit (up to 16,0kW)
CZ-CAPEK2	CZ-CAPE2	3-Pipe control PCB
		3-Pipe control PCB for wall mounted

#### 3-Pipe control box kit

CZ-P456HR3	4 ports 3 pipe box (up to 5,6kW)
CZ-P656HR3	6 ports 3 pipe box (up to 5,6kW)
CZ-P856HR3	8 ports 3 pipe box (up to 5,6kW)
CZ-P4160HR3	4 ports 3 pipe box (up to 16,0kW)

1) EER and COP calculation is based in accordance to EN14511. 2) SEER/SCOP is calculated based on the seasonal space cooling/heating efficiency  $\eta$  values of the COMMISSION REGULATION (EU) 2016/2281. SEER, SCOP =  $(\eta + \text{Correction}) \times \text{PEF}$ .



## 3-PIPE ECOi MF2 6N SERIES COMBINATION FROM 18 TO 48HP



HP			18HP	20HP	22HP	24HP	26HP	28HP	30HP	32HP
Standard model			U-8MF2E8 U-10MF2E8	U-8MF2E8 U-12MF2E8	U-8MF2E8 U-14MF2E8	U-8MF2E8 U-16MF2E8	U-12MF2E8 U-14MF2E8	U-14MF2E8 U-14MF2E8	U-14MF2E8 U-16MF2E8	U-16MF2E8 U-16MF2E8
Power supply	Voltage	V	380/400/415	380/400/415	380/400/415	380/400/415	380/400/415	380/400/415	380/400/415	380/400/415
	Phase		Three Phase	Three Phase	Three Phase	Three Phase	Three Phase	Three Phase	Three Phase	Three Phase
	Frequency	Hz	50	50	50	50	50	50	50	50
Cooling capacity		kW	50,40	56,00	61,50	68,00	73,00	78,50	85,00	90,00
EER <sup>1)</sup>		W/W	4,27	3,97	3,80	3,68	3,58	3,49	3,41	3,38
Running current	380V	A	19,70	23,80	27,00	30,90	33,70	37,20	41,10	43,90
	400V	A	18,90	22,90	26,00	29,70	32,40	35,70	39,50	42,20
	415V	A	18,40	22,30	25,30	28,90	31,50	34,80	38,50	41,10
Input power		kW	11,80	14,10	16,20	18,50	20,40	22,50	24,90	26,60
Heating capacity		kW	56,50	63,00	69,00	76,50	81,50	87,50	95,00	100,00
COP <sup>1)</sup>		W/W	4,63	4,47	4,57	4,20	4,38	4,49	4,20	4,03
Running current	380V	A	20,40	23,80	25,20	30,40	31,10	32,60	37,70	41,70
	400V	A	19,60	22,90	24,20	29,20	29,80	31,30	36,20	40,10
	415V	A	19,10	22,30	23,60	28,50	29,10	30,50	35,30	39,10
Input power		kW	12,20	14,10	15,10	18,20	18,60	19,50	22,60	24,80
Air volume		m <sup>3</sup> /min	336	370	370	370	424	424	424	424
Sound pressure	Hi / Lo	dB(A)	61,00 / 58,00	62,50 / 59,50	63,00 / 60,00	63,00 / 60,00	64,50 / 61,50	65,00 / 62,00	65,00 / 62,00	65,00 / 62,00
Dimension / Net weight	HxWxD	mm / kg	1758 x 2060 x 930 / 538	1758 x 2060 x 930 / 538	1758 x 2060 x 930 / 591	1758 x 2060 x 930 / 591	1758 x 2060 x 930 / 636	1758 x 2060 x 930 / 644	1758 x 2060 x 930 / 644	1758 x 2060 x 930 / 644
Piping connections	Suction pipe	Inch (mm)	1-1/8(28,58)	1-1/8(28,58)	1-1/8(28,58)	1-1/8(28,58)	1 1/4(31,75)	1 1/4(31,75)	1 1/4(31,75)	1 1/4(31,75)
	Discharge pipe	Inch (mm)	7/8(22,22)	7/8(22,22)	1(25,40)	1(25,40)	1(25,40)	1-1/8(28,58)	1-1/8(28,58)	1-1/8(28,58)
	Liquid pipe	Inch (mm)	5/8(15,88)	5/8(15,88)	5/8(15,88)	5/8(15,88)	3/4(19,05)	3/4(19,05)	3/4(19,05)	3/4(19,05)
	Balance pipe	Inch (mm)	1/4(6,35)	1/4(6,35)	1/4(6,35)	1/4(6,35)	1/4(6,35)	1/4(6,35)	1/4(6,35)	1/4(6,35)
Refrigerant (R410A)		kg/TCD <sub>2</sub> Eq.	16,80 / 35,0784	17,10 / 35,7048	17,60 / 36,7488	17,60 / 36,7488	18,10 / 37,7928	18,60 / 38,8368	18,60 / 38,8368	18,60 / 38,8368
Operating range	Cool Min ~ Max	°C	-10 ~ +46	-10 ~ +46	-10 ~ +46	-10 ~ +46	-10 ~ +46	-10 ~ +46	-10 ~ +46	-10 ~ +46
	Heat Min ~ Max	°C	-20 ~ +18	-20 ~ +18	-20 ~ +18	-20 ~ +18	-20 ~ +18	-20 ~ +18	-20 ~ +18	-20 ~ +18
	Simultaneous op.	°C	-10 ~ +24	-10 ~ +24	-10 ~ +24	-10 ~ +24	-10 ~ +24	-10 ~ +24	-10 ~ +24	-10 ~ +24







## With simultaneous heating and cooling operation heat recovery type.

ECOi 3-Pipe is one of the most advanced VRF systems available. Not only offering high-efficiency and performance for simultaneous heating and cooling, its sophisticated design makes installation and maintenance much easier.

- Achieves COP 4,63 as the top class in the industry (average cooling and heating value for 18HP outdoor unit)
- Simultaneous cooling or heating operation for up to 52 indoor units
- Small installation space, top class in the industry
- Rotation operation function and back-up operation function provided

- Standardisation of outdoor unit to one compact casing size
- Improved operation efficiency
- The constant-speed compressor adopts a high-performance internal high-pressure scroll
- Improvement of the heat exchanger
- Redesign of structural parts
- Close side-by-side installation is possible

### Technical focus

HP			34HP	36HP	38HP	40HP	42HP	44HP	46HP	48HP
Standard model			U-8MF2E8	U-8MF2E8	U-8MF2E8	U-8MF2E8	U-14MF2E8	U-14MF2E8	U-14MF2E8	U-16MF2E8
			U-12MF2E8	U-14MF2E8	U-14MF2E8	U-16MF2E8	U-14MF2E8	U-14MF2E8	U-16MF2E8	U-16MF2E8
			U-14MF2E8	U-14MF2E8	U-16MF2E8	U-16MF2E8	U-14MF2E8	U-16MF2E8	U-16MF2E8	U-16MF2E8
Power supply	Voltage	V	380/400/415	380/400/415	380/400/415	380/400/415	380/400/415	380/400/415	380/400/415	380/400/415
	Phase		Three Phase	Three Phase	Three Phase	Three Phase	Three Phase	Three Phase	Three Phase	Three Phase
	Frequency	Hz	50	50	50	50	50	50	50	50
Cooling capacity		kW	96,00	101,00	107,00	113,00	118,00	124,00	130,00	135,00
EER <sup>1)</sup>		W/W	3,74	3,66	3,60	3,55	3,48	3,43	3,40	3,38
Running current	380V	A	42,90	46,10	49,60	53,10	56,00	59,60	63,80	65,90
	400V	A	41,20	44,30	47,60	51,00	53,80	57,30	61,30	63,30
	415V	A	39,70	43,10	46,40	49,70	52,40	55,80	59,70	61,70
Input power		kW	25,70	27,60	29,70	31,80	33,90	36,10	38,20	39,90
Heating capacity		kW	108,00	113,00	119,00	127,00	132,00	138,00	145,00	150,00
COP <sup>1)</sup>		W/W	4,44	4,52	4,33	4,12	4,46	4,30	4,14	4,03
Running current	380V	A	41,00	41,60	46,10	52,20	49,30	53,80	58,80	62,60
	400V	A	39,40	39,90	44,30	49,60	47,30	51,60	56,50	60,10
	415V	A	38,40	38,90	43,10	47,80	46,10	50,30	55,00	58,60
Input power		kW	24,30	25,00	27,50	30,80	29,60	32,10	35,00	37,20
Air volume		m <sup>3</sup> /min	582	582	582	582	636	636	636	636
Sound pressure	Hi / Lo	dB(A)	65,00 / 62,00	65,50 / 62,50	65,50 / 62,50	65,50 / 62,50	67,00 / 64,00	67,00 / 64,00	67,00 / 64,00	67,00 / 64,00
Dimension / Net weight	H x W x D	mm / kg	1758 x 3120 x 930 / 905	1758 x 3120 x 930 / 913	1758 x 3120 x 930 / 913	1758 x 3120 x 930 / 913	1758 x 3120 x 930 / 966	1758 x 3120 x 930 / 966	1758 x 3120 x 930 / 966	1758 x 3120 x 930 / 966
Piping connections	Suction pipe	Inch (mm)	1 1/4 (31,75)	1-1/2 (38,10)	1-1/2 (38,10)	1-1/2 (38,10)	1-1/2 (38,10)	1-1/2 (38,10)	1-1/2 (38,10)	1-1/2 (38,10)
	Discharge pipe	Inch (mm)	1-1/8 (28,58)	1-1/8 (28,58)	1 1/4 (31,75)	1 1/4 (31,75)	1 1/4 (31,75)	1 1/4 (31,75)	1 1/4 (31,75)	1 1/4 (31,75)
	Liquid pipe	Inch (mm)	3/4 (19,05)	3/4 (19,05)	3/4 (19,05)	3/4 (19,05)	3/4 (19,05)	3/4 (19,05)	3/4 (19,05)	3/4 (19,05)
	Balance pipe	Inch (mm)	1/4 (6,35)	1/4 (6,35)	1/4 (6,35)	1/4 (6,35)	1/4 (6,35)	1/4 (6,35)	1/4 (6,35)	1/4 (6,35)
Refrigerant (R410A)		kg / TCO <sub>2</sub> Eq.	26,40 / 55,1232	26,90 / 56,1672	26,90 / 56,1672	26,90 / 56,1672	27,90 / 58,2552	27,90 / 58,2552	27,90 / 58,2552	27,90 / 58,2552
Operating range	Cool Min ~ Max	°C	-10 ~ +46	-10 ~ +46	-10 ~ +46	-10 ~ +46	-10 ~ +46	-10 ~ +46	-10 ~ +46	-10 ~ +46
	Heat Min ~ Max	°C	-20 ~ +18	-20 ~ +18	-20 ~ +18	-20 ~ +18	-20 ~ +18	-20 ~ +18	-20 ~ +18	-20 ~ +18
	Simultaneous op.	°C	-10 ~ +24	-10 ~ +24	-10 ~ +24	-10 ~ +24	-10 ~ +24	-10 ~ +24	-10 ~ +24	-10 ~ +24

#### Solenoid valve kit

KIT-P56HR3	KIT-P56HR3	3-Pipe control Solenoid valve kit (up to 5,6kW)
	CZ-P56HR3	Solenoid valve kit (up to 5,6kW)
	CZ-CAPE2	3-Pipe control PCB
KIT-P160HR3	KIT-P160HR3	3-Pipe control Solenoid valve kit (from 5,6 to 10,6kW)
	CZ-P160HR3	Solenoid valve kit (up to 16,0kW)
	CZ-CAPE2	3-Pipe control PCB
CZ-CAPEK2		3-Pipe control PCB for wall mounted

#### 3-Pipe control box kit

CZ-P456HR3	4 ports 3 pipe box (up to 5,6kW)
CZ-P656HR3	6 ports 3 pipe box (up to 5,6kW)
CZ-P856HR3	8 ports 3 pipe box (up to 5,6kW)
CZ-P4160HR3	4 ports 3 pipe box (up to 16,0kW)

1) EER and COP calculation is based in accordance to EN14511.

# ECO G, THE GAS DRIVEN VRF





The advanced Gas Driven VRF system offers increased efficiency and performance across the range. Improvements include increased part load performance, reduced gas consumption with a Miller-cycle engine and reduced electrical consumption by using DC-Fan motors.

### 1 Limited electric supply

Electric consumption of ECO G is only 9% compared to ECOi because gas engine is utilized for the compressor driving source.

### 2 High demand of DHW with heating and cooling cogeneration

DHW is produced effectively thanks to heat from engine exhaust during heating and cooling.

### 3 Open and flexible design

ECO G system is designed to connect various Indoor units and controllers which is available for ECOi system. With new GE3 series, Pump down system has been also implemented to answer commercial needs.

### 4 Quick start up in heating at low ambient temperature

Gas heat pump systems make your building comfortably warm by a quick start up with waste heat from engine. Heating mode works from -21°C of ambient temperature.

Comparison of heating capacity.

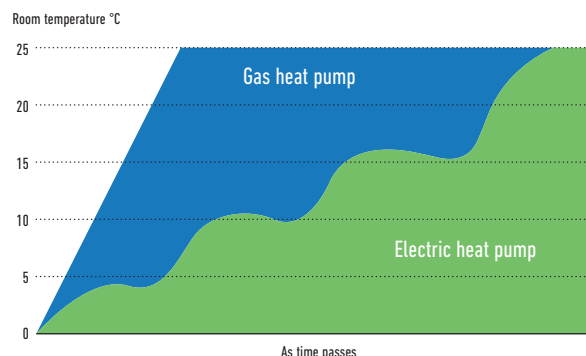

#### 2-Pipe ECO G GE3 Series

Designed for better energy efficiency. SEER has been increased by maximum 120%.



#### NEW 3-Pipe ECO G GF3 Series

Domestic hot water can be supplied by effectively using waste heat generated by heating & cooling.

#### GE3/GF3 connectable indoor units

Type	Model number reference	2-Pipe ECO G GE3 Series	NEW 3-Pipe ECO G GF3 Series
Standard A2A indoor units	—	Yes <sup>1</sup>	Yes <sup>1</sup>
Water Heat Exchanger	PAW-WX4E5N/5N2	Yes <sup>2</sup>	No
High Static Pressure Hide Away	S-ME2E5	Yes	No
Heat Recovery with DX Coil	PAW-ZDX3N	Yes	Yes
Air Curtain with DX Coil	PAW-EAIRC-MJ/MS	Yes	Yes <sup>3</sup>
AHU Connection Kit	PAW-MAH2/M/L	Yes	Yes <sup>3</sup>

1) Except for 1,5kW capacity. 2) Allowed 1:1 and also mixed. If mixed, not operate at the same time WHE + DX only operate separately. 3) Smaller capacity than 16kW only.

# ECO G, THE GAS DRIVEN VRF

**200.000**  
GHP outdoor units  
were sold in all over  
the world

ECO G satisfies special requirement for your application and environmentally friendly solution by Panasonic professional technology.

Reliable quality by long development history since 1985.

Our ECO G VRF range of commercial systems is leading the industry in the development of efficient and flexible systems



## What is GHP? The Gas Heat Pump (GHP)

Panasonic Gas Heat Pump is a direct expansion system with compressor as same as VRF system. Gas engine is used as driving source of compressor instead of electric motor. This gas engine compressor drive has 2 advantages:

1. Waste heat from the gas engine available
2. No need for motor power consumption thanks to gas engine

GHP is the natural choice for commercial projects, especially for those projects where power restrictions apply.

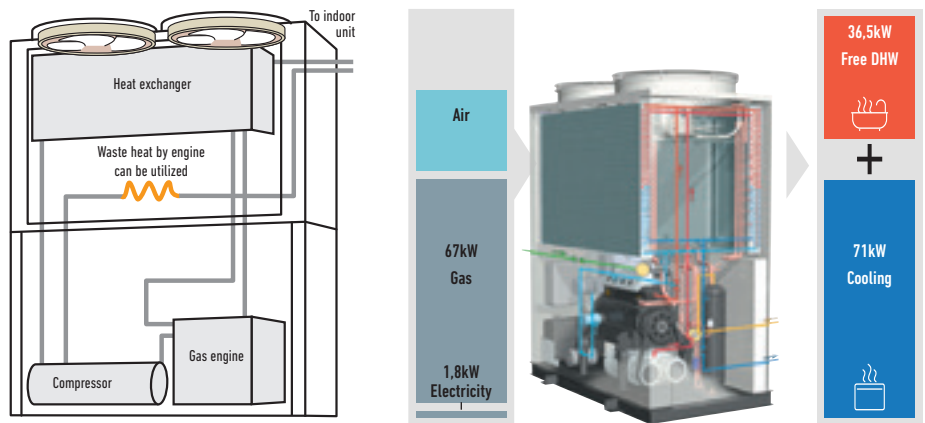

\* Regarding a 25HP model.

## Power supply problems?

If you are short of electric power, our ECO G is a perfect solution.

- Runs on natural gas or LPG and just needs single phase supply
- Enables the building's electrical power supply to be used for other critical electrical demands
- Reduces capital cost to upgrade power substations to run heating and cooling systems
- Reduces power loadings within a building especially during peak periods
- Electricity supply freed up for other uses such as IT servers, commercial refrigeration, manufacturing, lighting, etc...

### Limited electricity area.

Comparison of electrical consumption on a 71kW outdoor unit.

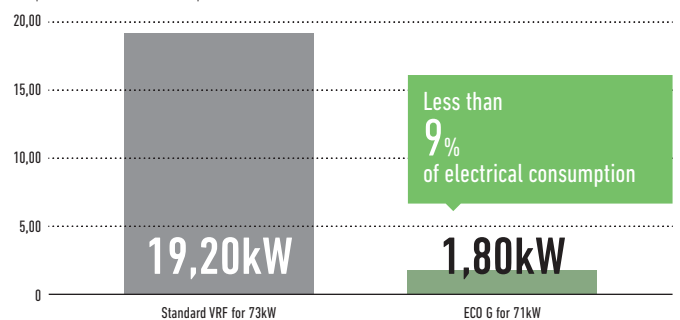

## High demand of Domestic Hot Water in heating and cooling

The rejected heat from the engine is available for DHW production and can supply up to 46kW of hot water at 65°C. DHW at 65°C is also ready to use in heating without additional electric heaters.

### Application example: Hotel

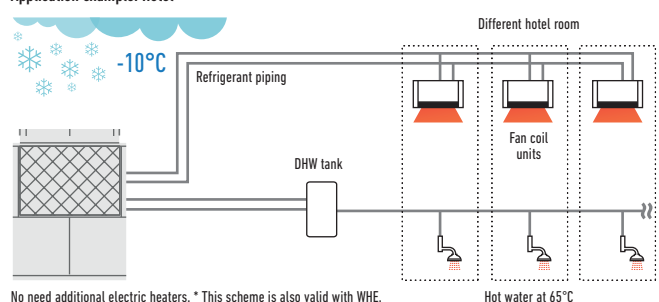

### Quick start up and great heating capacity at low ambient temperature

Waste heat from gas engine is utilized to raise temperature quicker than electric VRF system.

This contributes great heating capacity at extremely low ambient temperature.

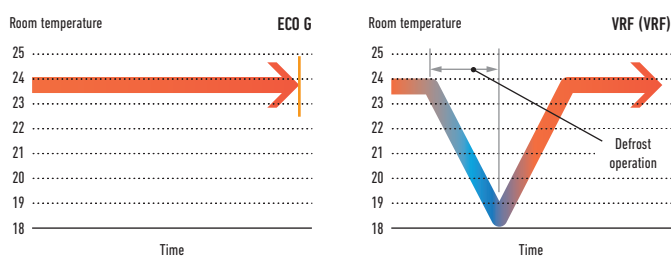

### Lowest nitrogen oxide emissions.

The ECO G VRF systems have low nitrogen oxide emissions. In a pioneering development, the Panasonic ECO G features a brand new lean-burn combustion system that utilizes air fuel ratio feedback control to reduce NOx emissions to an all time low.

### Water chiller option.

Our ECO G system is also available with a water chiller option, which can be combined with individual outdoor units or as part of a DX chilled water mix of indoor units. The system can be operated via a BMS system or a Panasonic supplied control panel, with chilled water set points from -15°C ~ +15°C and heating set points 35°C ~ +55°C.

### Application

Application	Condition	ECO G
Hotel	High DHW demand	✓
Hotel	Needs to warm up swimming pool	✓ Energy recovery of ECO G system can fulfill different requirement
Office	Quick start up is necessary	✓ Speed of start up is quicker than VRF system
Winery	1) Outlet water demand at specific temperature 2) Needs high amount of power temporary (not every month)	✓ 1) Chiller application with hydro module (ECO G + WHE) can make this special process ✓ 2) Running cost can be saved since fixed Gas tariff per month is cheaper than fixed electric tariff.
Any building	In a city with power restriction	✓ - No need an additional power transformer - Space and cost can be saved
	At extremely low ambient condition	✓ Heating capacity is kept up to -20°C without defrost process

### Project Case Studies



#### Savills HQ Dublin & Google Block R. Ireland.

ECO G 3-way units with a 243kW load. The project has been such a success that it has recently been awarded a Panasonic PRO Award for Best Contribution of efficient projects within Europe.



#### Thomas Cook's Sunprime Atlantic View resort.

A holiday resort in the Canaries, Spain. 229 rooms plus full spa and swimming pool facility.



#### CAPITA call centre. UK.

11 ECO G 3-way units. Over 150 indoor units in meeting rooms and open-plan areas. Intelligent touch screen controller, the CZ-256ESMC2.



#### French winery Genevilliers, France.

ECO G 3-way units. One of the best solution utilized our ECO G solution for wine production process.

# ECO G 3 SERIES

## Improvement in blast efficiency

### New 3-blades fan.

Propeller shape with 3 blades is more efficient  
Max. 30% of fan electrical consumption is saved compared to conventional fan.

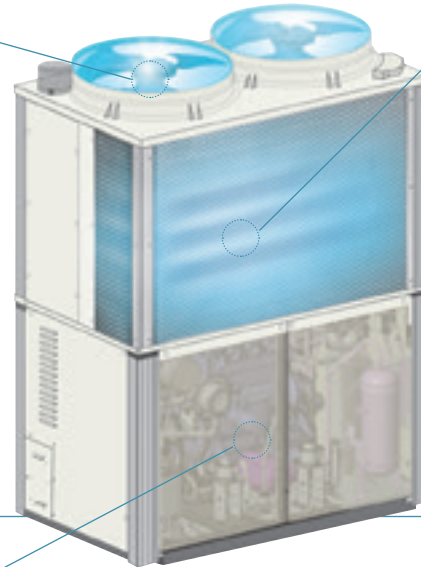
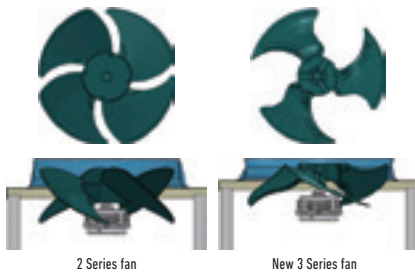

## New "L" type heat exchanger

Heat exchanger surface area is included by 25% compared to conventional model to optimize efficiency.

Heat exchanger surface area **25% up**

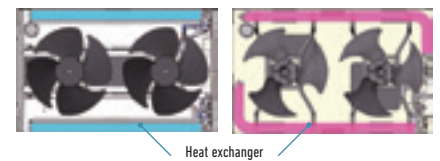

## Better partial load control

Reduce start / stop loss has reduced by expanding the are where continuous operation is possible. Annual operation efficiency has further improved by better efficiency at lower partial load.

## Compressor.

- Amount of internal leakage has reduced by the reduction of clearance, the compressor efficiency in the low load and low rotation region has been greatly improved.
- Moreover, efficiency of high speed and high load is also improved by reduction of suction pressure loss due to expansion of suction path
- Optimize compressor capacity

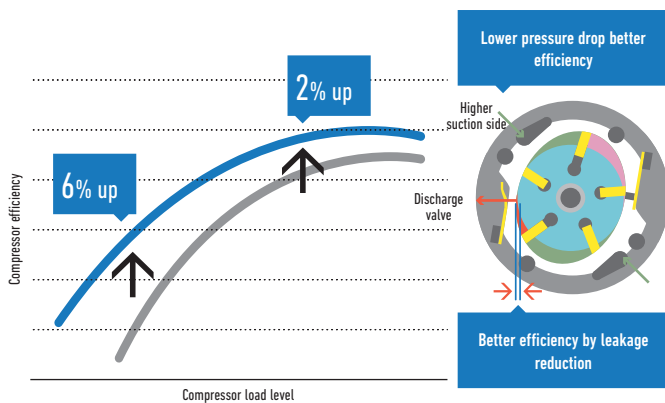

## Engine.

- Continuous operation area has expanded at lower partial load by expanding operation area of lower speed
- Engine efficiency has improved by shifting output points to higher torque side

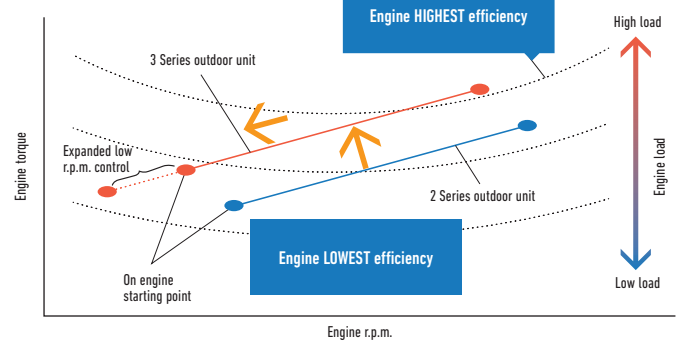

## Engine pulley.

- Bigger diameter of engine pulley contributes the optimization of the compressor rotation speed ratio with engine speed
- Higher engine pulley diameter giving better performance at partial load and reducing ON/OFF operation.

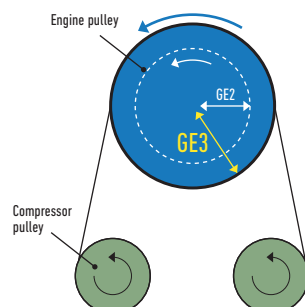

## Line up of GE3 2-Pipe W-Multi

- For new or renewal
- Available for water heat exchanger
- Maximum 60HP combination

Introducing new ECO G 3 Series.  
Optimized energy saving with reliable Panasonic technologies.

The highest seasonal performance in all capacity ranges

High power efficiency of W-Multi system.

ECO G 3 Series system offers seasonal efficiency which has been drastically improved with new heat exchanger design, blast efficiency, partial load control.

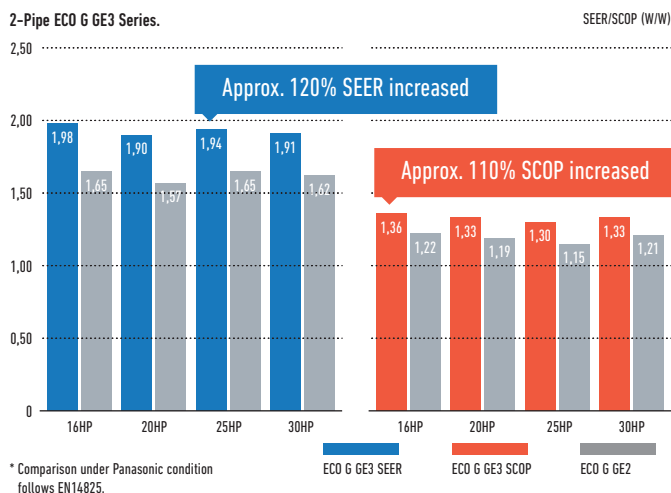

Compared to conventional model ECO G 2 Series.

All models are newly developed and have maximum 25% of SEER, 15% of SCOP better than conventional model.

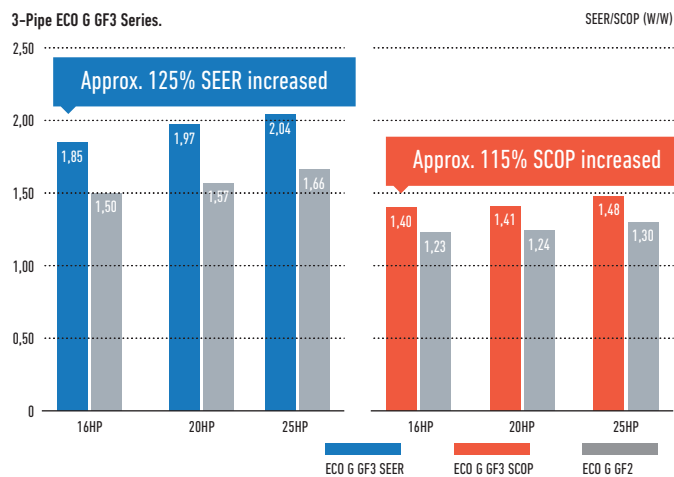

Heating design operation conditions (GE3)

Operating range in heating has been expanded up to 24°C (WB) for air to water system to meet the demand of swimming pool application.

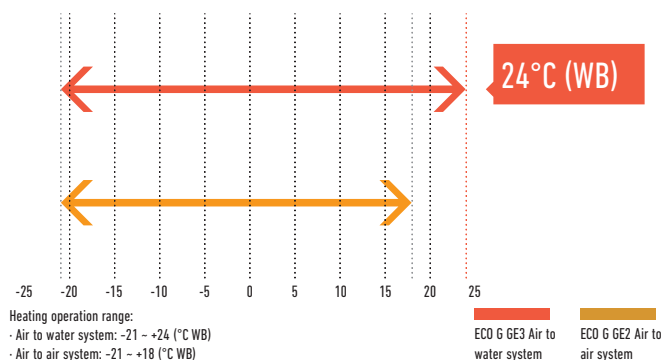

DHW priority mode setting in heating (GE3)

Ambient temperature range for DHW production is expandable by setting depending on DHW needs. Hot water at 65°C is available in heating without additional electric heaters.

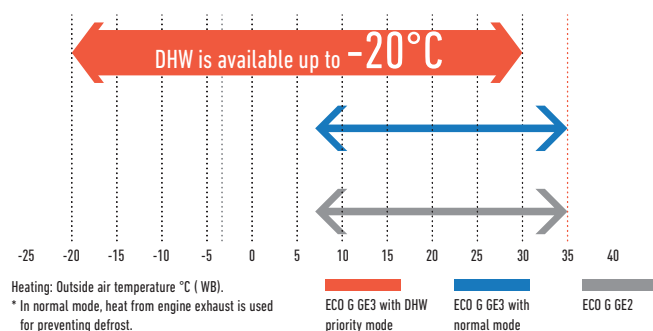

No defrost requirement (GE3 / GF3)

No defrost mode is selectable to get higher capacity under low ambient temperature.

Flexible design with wide line up of indoor units

The advanced GE3 series can connect up to 64 indoor units.

Series	16HP	20HP	25HP	30HP	32HP	36HP	40HP	45HP	50HP	55HP	60HP
2-Pipe ECO G GE3 Series	26	33	41	50	52	59	64	64	64	64	64
3-Pipe ECO G GF3 Series	24	24	24	—	—	—	—	—	—	—	—

# 2-PIPE ECO G GE3 SERIES



The new GE3 Series has a top level of seasonal efficiency in this category. In addition, this product fits with special needs for commercial application thanks to DHW priority setting and Auto pump down functions.

### Technical focus

- Superior seasonal energy efficiency, maximum 240,1%
- DHW priority setting
- Operating range in heating down to -21°C and up to +24°C for air to water system
- No defrost cycle
- Capacity ratio 50 ~ 200%<sup>1)</sup>
- 0-10V control demand by a connection with 3rd party controllers (CZ-CAPBC2 required)
- Option of DX or chilled water for indoor heat exchange
- Maximum total piping length: 780m

1) 50 ~ 200% only when one outdoor unit is installed. In other cases 50 ~ 130%.

HP			16HP	20HP	25HP	30HP
Model			U-16GE3E5	U-20GE3E5	U-25GE3E5	U-30GE3E5
Power supply	Voltage	V	220 / 230 / 240	220 / 230 / 240	220 / 230 / 240	220 / 230 / 240
	Phase		Single Phase	Single Phase	Single Phase	Single Phase
	Frequency	Hz	50	50	50	50
Cooling capacity		kW	45,00	56,00	71,00	85,00
Refrigeration load Pdesign		kW	45,00	56,00	71,00	85,00
<b>ηsc (LOT21)<sup>1</sup></b>		<b>%</b>	<b>220,60</b>	<b>219,30</b>	<b>240,10</b>	<b>229,30</b>
Input power cooling		kW	1,17	1,12	1,80	1,80
Hot water in cooling mode (at 65°C outlet)		kW	23,60	29,10	36,40	46,00
Max COP in hot water		W/W	1,55	1,55	1,49	1,47
Gas consumption cooling		kW	41,10	52,10	67,20	84,10
Heating capacity	Standard	kW	50,00	63,00	80,00	95,00
	Low temperature	kW	53,00	67,00	78,00	90,00
Refrigeration load Pdesign		kW	37,00	53,00	60,00	65,00
<b>ηsh (LOT21)<sup>1</sup></b>		<b>%</b>	<b>150,60</b>	<b>143,70</b>	<b>146,90</b>	<b>151,30</b>
Input power heating		kW	0,56	1,05	0,91	1,75
Gas consumption heating	Standard	kW	38,00	51,10	68,60	75,30
	Low temperature	kW	45,40	62,70	60,70	73,90
Starter amperes		A	30	30	30	30
External static pressure		Pa	10	10	10	10
Air volume		m <sup>3</sup> /min	370	420	460	460
Sound power		dB	80 / 77	80 / 77	84 / 81	84 / 81
Dimension	HxWxD	mm	2255 x 1650 x 1000	2255 x 1650 x 1000	2255 x 2026 x 1000	2255 x 2026 x 1000
Net weight		kg	765	765	870	880
Piping connections	Liquid pipe	Inch (mm)	1/2 (12,70)	5/8 (15,88)	5/8 (15,88)	3/4 (19,05)
	Gas pipe	Inch (mm)	1-1/8 (28,58)	1-1/8 (28,58)	1-1/8 (28,58)	1-1/4 (31,75)
	Balance pipe	Inch (mm)	—	—	—	—
Elevation difference (in/out)			50	50	50	50
Refrigerant (R410A)		kg / TCO <sub>2</sub> Eq.	11,50 / 24,00	11,50 / 24,00	11,50 / 24,00	11,50 / 24,00
Maximum number of connectable indoor units			26	33	41	50
Operating range	Cool Min ~ Max	°C (DB)	-10 ~ +43	-10 ~ +43	-10 ~ +43	-10 ~ +43
	Heat Min ~ Max	°C (WB)	-21 ~ +18	-21 ~ +18	-21 ~ +18	-21 ~ +18

1) SEER/SCOP is calculated based on the seasonal space cooling/heating efficiency "η" values of the COMMISSION REGULATION (EU) 2016/2281.

Hot water take out function added, EU safety regulation standard cleared. 25HP chassis enlarged due to specification improvement. Pre-coat corrosion fin. Auto pump down function.





# 2-PIPE ECO G GE3 SERIES COMBINATION



The new GE3 Series has a top level of seasonal efficiency in this category. In addition, this product fits with special needs for commercial application thanks to DHW priority setting and Auto pump down functions.

## Technical focus

- Maximum 60HP combination
- Superior seasonal energy efficiency, maximum 240,1%
- DHW priority setting
- Operating range in heating down to -21°C and up to +24°C for air to water system
- No defrost cycle
- 0-10V control demand by a connection with 3rd party controllers (CZ-CAPBC2 required)
- Option of DX or chilled water for indoor heat exchange
- Maximum total piping length: 780m

HP			32HP	36HP	40HP	45HP	50HP	55HP	60HP
Model			U-16GE3E5	U-16GE3E5	U-20GE3E5	U-20GE3E5	U-25GE3E5	U-25GE3E5	U-30GE3E5
			U-16GE3E5	U-20GE3E5	U-20GE3E5	U-25GE3E5	U-25GE3E5	U-30GE3E5	U-30GE3E5
Power supply	Voltage	V	220 / 230 / 240	220 / 230 / 240	220 / 230 / 240	220 / 230 / 240	220 / 230 / 240	220 / 230 / 240	220 / 230 / 240
	Phase		Single Phase	Single Phase	Single Phase	Single Phase	Single Phase	Single Phase	Single Phase
	Frequency	Hz	50	50	50	50	50	50	50
Cooling capacity		kW	90,00	101,00	112,00	127,00	142,00	156,00	170,00
Input power cooling		kW	2,34	2,29	2,24	2,92	3,60	3,60	3,60
Hot water in cooling mode (at 65°C outlet)		kW	47,20	52,70	58,20	65,50	72,80	82,40	92,00
Max COP in hot water		W/W	1,55	1,55	1,55	1,52	1,49	1,48	1,47
Gas consumption cooling		kW	82,20	93,20	104,20	119,30	134,40	151,30	168,20
Heating capacity	Standard	kW	100,00	113,00	126,00	143,00	160,00	175,00	190,00
	Low temperature	kW	106,00	120,00	134,00	145,00	156,00	168,00	180,00
Input power heating		kW	1,12	1,61	2,10	1,96	1,82	2,66	3,50
Gas consumption heating	Standard	kW	76,00	89,10	102,20	119,70	137,20	143,90	150,60
	Low temperature	kW	90,80	108,10	125,40	123,40	121,40	134,60	147,80
Starter amperes		A	30	30	30	30	30	30	30
External static pressure		Pa	10	10	10	10	10	10	10
Air volume		m <sup>3</sup> /min	370 / 370	370 / 420	420 / 420	420 / 460	460 / 460	460 / 460	460 / 460
Sound power		dB	83 / 80	83 / 80	83 / 80	86 / 83	87 / 84	87 / 84	87 / 84
Dimension	Height	mm	2255	2255	2255	2255	2255	2255	2255
	Width	mm	1650 + 100 + 1650	1650 + 100 + 1650	1650 + 100 + 1650	1650 + 100 + 2026	2026 + 100 + 2026	2026 + 100 + 2026	2026 + 100 + 2026
	Depth	mm	1000	1000	1000	1000	1000	1000	1000
Net weight		kg	1530 (765 + 765)	1530 (765 + 765)	1530 (765 + 765)	1635 (765 + 870)	1740 (870 + 870)	1750 (870 + 880)	1760 (880 + 880)
Piping connections	Liquid pipe	Inch (mm)	3/4 (19,05)	3/4 (19,05)	3/4 (19,05)	3/4 (19,05)	3/4 (19,05)	7/8 (22,22)	7/8 (22,22)
	Gas pipe	Inch (mm)	1-1/4 (31,75)	1-1/4 (31,75)	1-1/2 (38,10)	1-1/2 (38,10)	1-1/2 (38,10)	1-1/2 (38,10)	1-1/2 (38,10)
	Balance pipe	Inch (mm)	—	—	—	—	—	—	—
Elevation difference (in/out)			50	50	50	50	50	50	50
Refrigerant (R410A)		kg / TCO <sub>2</sub> Eq.	2x 11,50 / 24,00	2x 11,50 / 24,00	2x 11,50 / 24,00	2x 11,50 / 24,00	2x 11,50 / 24,00	2x 11,50 / 24,00	2x 11,50 / 24,00
Maximum number of connectable indoor units			52	59	64	64	64	64	64
Operating range	Cool Min ~ Max	°C	-10 ~ +43	-10 ~ +43	-10 ~ +43	-10 ~ +43	-10 ~ +43	-10 ~ +43	-10 ~ +43
	Heat Min ~ Max	°C	-21 ~ +18	-21 ~ +18	-21 ~ +18	-21 ~ +18	-21 ~ +18	-21 ~ +18	-21 ~ +18

Data is for reference. Hot water take out function added, EU safety regulation standard cleared. 25HP chassis enlarged due to specification improvement. Pre-coat corrosion fin. Auto pump down function.



# 3-PIPE ECO G GF3 SERIES



## Power supply problems?

If you are short of electrical power, our gas heat pump could be the perfect solution:

- Runs on natural gas or LPG and just needs Single Phase supply
- Enables the building's electrical power supply to be used for other critical electrical demands
- Reduces capital cost to upgrade power substations to run heating and cooling systems
- Reduces power loadings within a building especially during peak periods
- Electricity supply freed up for other uses such as IT servers, commercial refrigeration, manufacturing, lighting etc.

## ECO G Outdoor Heat Exchanger.

- Integrated DX and hot water coil
- No defrost required
- Faster reaction to demand for heating

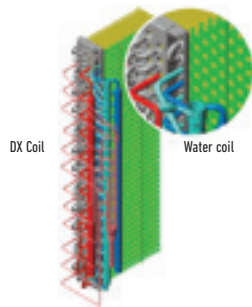

## DHW production in heating and cooling

Free DHW is available 365 days a year, in all seasons. Hot water is produced effectively from waste heat from engine. Perfect solution for hotel projects required high demand of hot water.

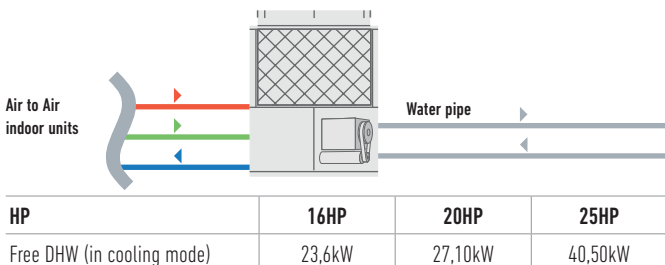

## Excellent performance and free Domestic Hot Water

Panasonic 3-Pipe Multi system is capable of simultaneous heating/cooling and individual operation of each indoor unit by only one outdoor unit. As a result, efficient individual air conditioning is possible in buildings having diverse room temperatures.

In addition, Domestic Hot Water is created for free in cooling mode without additional boilers or electric heaters.

### System example.

Improved maintenance intervals. The unit only needs to be serviced every 10,000 hours. This is the best in the industry.

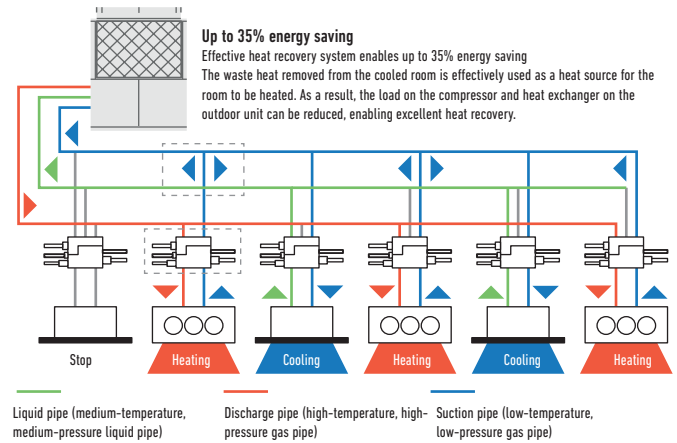

## Solenoid valve kit.

To be fitted on all 'zones' to allow simultaneous heating and cooling. Up to 24 indoor units are capable of simultaneous heating/cooling operation. Oil-recovery operation to gives more stable comfort air-conditioning control.

### 3-Pipe control Solenoid valve kit

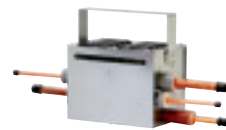

**CZ-P56HR3**  
Up to 5.6kW  
**CZ-P160HR3**  
Up to 16.0kW

**KIT-P56HR3**  
(CZ-P56HR3+CZ-CAPE2)  
**KIT-P160HR3**  
(CZ-P160HR3+CZ-CAPE2)

### 3-Pipe control PCB



**CZ-CAPE2\***  
3-Pipe control PCB

\* For wall mounted. Must be added to the CZ-P56HR3 or CZ-P160HR3.

**HOT WATER  
AT 65°C  
OUTLET FOR  
FREE**





## New 3-Pipe ECO G GF3 Series.

### DHW available in all seasons

Domestic hot water can be taken out from waste heat of engine effectively in heating & cooling - all year round.

### Outstanding seasonal energy efficiency, maximum 204,9%

- Capacity ratio 50 ~ 200%
- No defrost cycle
- Maximum total piping length: 780m

### Flexible installation

- Full heating capacity down to -21°C (WB)
- DHW production for all the year
- Maximum 24 indoor units connectable

HP			16HP	20HP	25HP
Model			U-16GF3E5	U-20GF3E5	U-25GF3E5
Power supply	Voltage	V	220 / 230 / 240	220 / 230 / 240	220 / 230 / 240
	Phase		Single Phase	Single Phase	Single Phase
	Frequency	Hz	50	50	50
Cooling capacity		kW	45,00	56,00	71,00
Refrigeration load Pdesign		kW	45,00	56,00	71,00
$\eta_{sc}$ (LOT21) <sup>1</sup>		%	<b>185,20</b>	<b>198,80</b>	<b>204,90</b>
Input power cooling		kW	1,17	1,40	1,80
Hot water in cooling mode (at 65°C outlet)		kW	23,60	27,10	40,50
Gas consumption cooling		kW	45,80	54,80	73,70
Heating capacity	Standard	kW	50,00	63,00	80,00
	Low temperature	kW	53,00	67,00	78,00
Refrigeration load Pdesign		kW	38,00	52,00	60,00
$\eta_{sh}$ (LOT21) <sup>1</sup>		%	<b>139,20</b>	<b>140,20</b>	<b>150,90</b>
Input power heating		kW	0,56	1,05	0,91
Gas consumption heating	Standard	kW	42,20	51,10	68,60
Starter amperes		A	30	30	30
Air volume		m <sup>3</sup> /min	370	400	460
Sound power		dB	80 / 77	81 / 78	84 / 81
Dimension	HxWxD	mm	2255 x 1650 x 1000	2255 x 1650 x 1000	2255 x 2026 x 1000
Net weight		kg	775	775	880
Piping connections	Gas	Inch (mm)	1 1/8 (28,58)	1 1/8 (28,58)	1 1/8 (28,58)
	Liquid	Inch (mm)	3/4 (19,05)	3/4 (19,05)	3/4 (19,05)
	Discharge	Inch (mm)	7/8 (22,22)	1 (25,40)	1 (25,40)
	Fuel gas		R3/4	R3/4	R3/4
	Exhaust drain port	mm	25	25	25
Elevation difference (in/out)		m	50	50	50
Refrigerant (R410A)		kg / TCO <sub>2</sub> Eq.	11,50 / 24,00	11,50 / 24,00	11,50 / 24,00
Maximum number of connectable indoor units			24	24	24
Operating range	Cool Min ~ Max	°C	-10 ~ +43	-10 ~ +43	-10 ~ +43
	Heat Min ~ Max	°C	-21 ~ +18	-21 ~ +18	-21 ~ +18

#### Solenoid valve kit

KIT-P56HR3	KIT-P56HR3	3-Pipe control Solenoid valve kit (up to 5,6kW)
	CZ-P56HR3	Solenoid valve kit (up to 5,6kW)
	CZ-CAPE2	3-Pipe control PCB
KIT-P160HR3	KIT-P160HR3	3-Pipe control Solenoid valve kit (from 5,6 to 10,6kW)
	CZ-P160HR3	Solenoid valve kit (up to 16,0kW)
	CZ-CAPE2	3-Pipe control PCB
CZ-CAPEK2		3-Pipe control PCB for wall mounted

#### 3-Pipe control box kit

CZ-P456HR3	4 ports 3 pipe box (up to 5,6kW)
CZ-P656HR3	6 ports 3 pipe box (up to 5,6kW)
CZ-P856HR3	8 ports 3 pipe box (up to 5,6kW)
CZ-P4160HR3	4 ports 3 pipe box (up to 16,0kW)



1) SEER/SCOP is calculated based on the seasonal space cooling/heating efficiency "η" values of the COMMISSION REGULATION (EU) 2016/2281.

Hot water take out function added, EU safety regulation standard cleared. 25HP chassis enlarged due to specification improvement. Pre-coat corrosion fin. Auto pump down function.

# NEW PANASONIC GHP/EHP HYBRID SYSTEM. FIRST INTELLIGENT TECHNOLOGY

GHP + EHP  
**HYBRID**  
VRF SYSTEM



Taking an advantage of Gas and Electricity to achieve better energy saving ever.

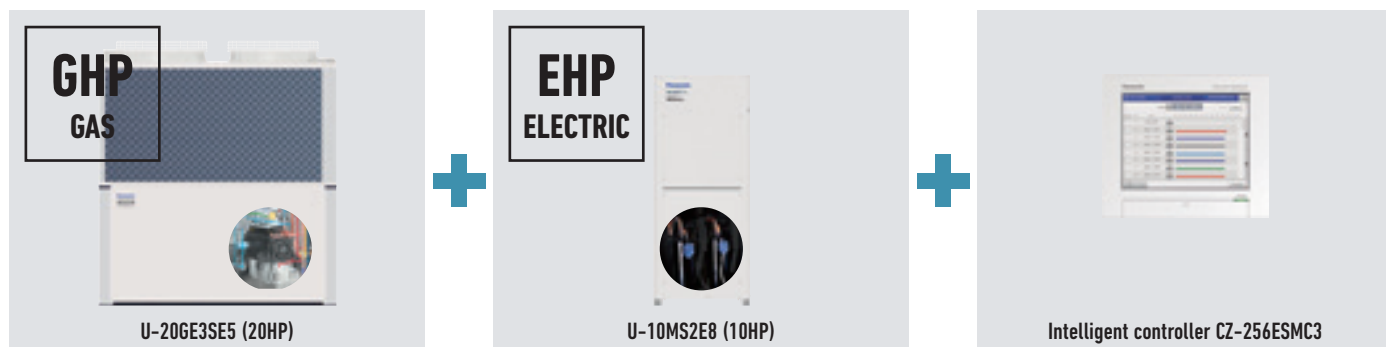

- Master unit GHP**
- Load calculation of GHP&EHP
  - Operation in accordance with the upper limit setting.
  - Individual capacity control
  - Device control
  - Special control (Defrost, Oil recovery, 4Way-valve matching / Abnormality processing)
- Slave Unit EHP**
- Intelligent controller**
- Demand monitoring
  - Indoor/Total load calculation
  - Operation Ratio Indication upper limit setting of MAP according to:
    - Energy unit price
    - Electric power demand
    - Air conditioning load

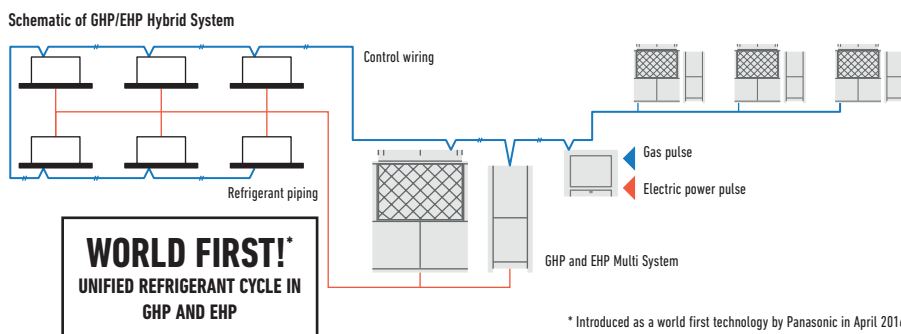

\* Introduced as a world first technology by Panasonic in April 2016.

### 1 Peak cut of electricity consumption

Electrical peak demand is significantly reduced thanks to GHP system consuming only 10% of electricity of EHP system.

\* Image of Hotel project.

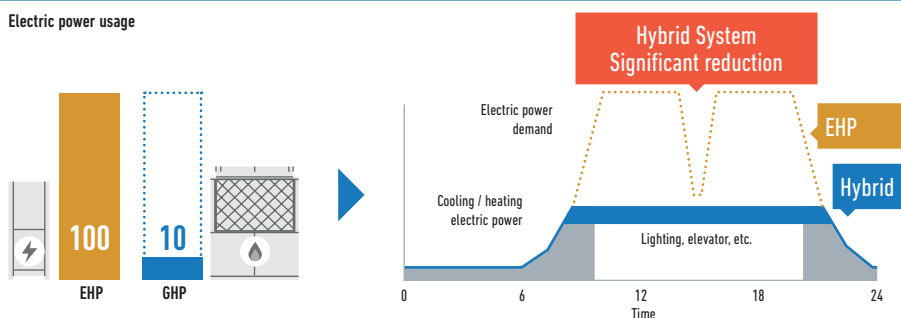

### 2 Optimal control to maximize energy saving

Switching the operation between GHP and EHP system on the basis of usage, energy demand, part load.

\* Specification is tentative.

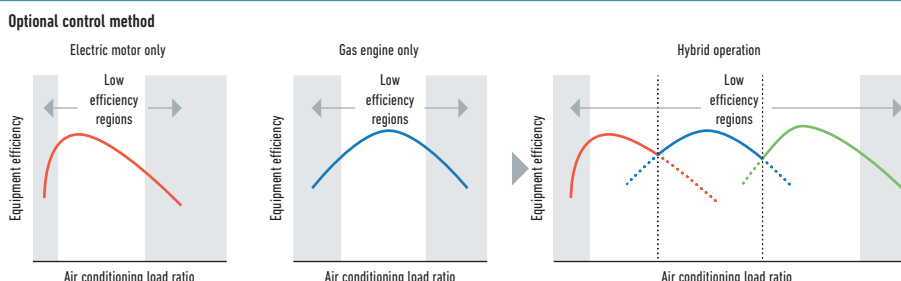

### 3 Free Hot Water production by GHP system

Hot water is effectively produced from waste heat of engine.

\* Specification is tentative.

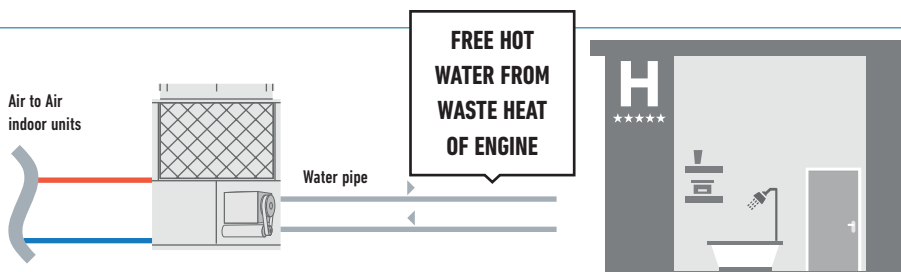

# WATER HEAT EXCHANGER FOR HYDRONIC APPLICATIONS

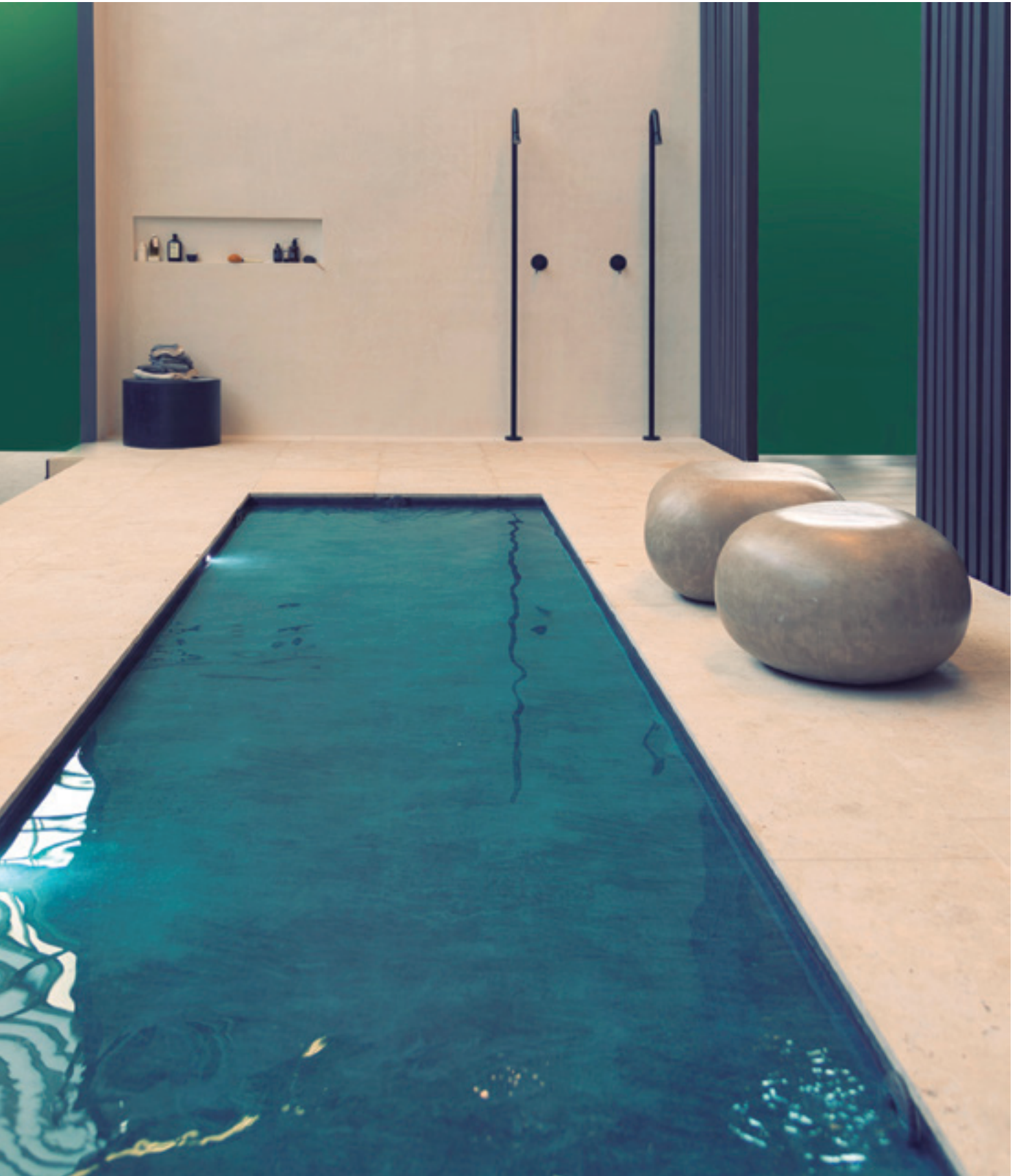

When a top London restaurant opened, it needed large volumes of fresh air to ensure the optimum dining environment. ECO G units connected to the cooling coils within the air handling equipment ensured the air was introduced in the right condition in both summer and winter.

**Chiller replacement. Chilled water supply to fan coils**

**Chiller replacement.**

When some old chillers needed replacing at the end of their operational lifetime, ECO Gs with Water Heat Exchangers enabled the project to be carried out in stages whilst still utilising the existing water pipe work and fan coils. This enabled the project to be delivered on time, to a restricted budget and avoided all issues regarding refrigerant in confined spaces.



**Connection to 'close control' computer equipment**

**Computer room applications.**

When all available electrical power needed to be utilised for the IT equipment for a leading international bank, the cooling load of over 450kW had to be powered by gas. The outdoor units were connected via Water Heat Exchangers to cooling coils inside the 'close control' units thereby maintaining a conditioned environment for temperature and humidity. By utilising the hot water function over 100kW of hot water are supplied to the building and therefore the additional benefit of considerable CO<sub>2</sub> savings is ensured.

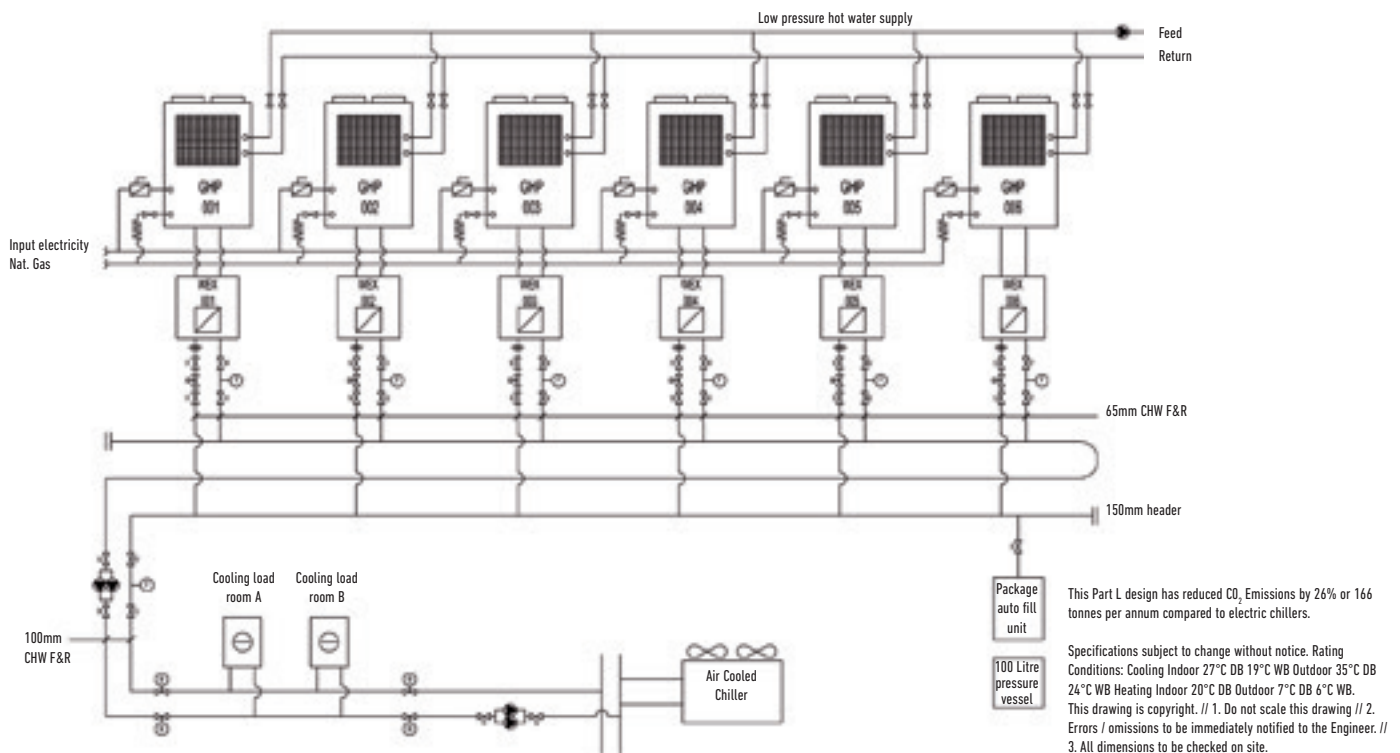

## 2-PIPE ECOi WITH WATER HEAT EXCHANGER FOR CHILLED AND HOT WATER PRODUCTION



### The Panasonic solution for chilled and hot water production!

#### For hydronic applications

Water Heat Exchanger (WHE) for ECOi. Operation and control by timer remote control CZ-RTC5B. Energy-efficient capacity control. Stainless steel plate heat exchanger with anti-freeze protection control. Change-over between heating and cooling operation.

#### Technical focus

- A class water pump included
- 4 Way valve included
- Heating, cooling and DHW
- Increased energy efficiency and low CO<sub>2</sub> emissions
- Water connections R2" f for 28kW and R2,5" f for 50kW
- Maximum distance between outdoor unit and WHE: 170m
- Maximum hot water outlet temperature: 45°C
- Minimum chilled water outlet temperature: 5°C
- Outdoor temperature range in cooling mode: +5°C to +43°C
- Outdoor temperature range in heating mode: -11°C to +15°C (with low temperature kit -25°C)

#### ECOi Water Heat Exchanger

Electrical VRF with Water Heat Exchanger

- With this easy to install Water Heat Exchanger unit, you can now cover projects up to 51kW hot water demand or 44kW on chilled application on a efficient way and cost effective

System example.

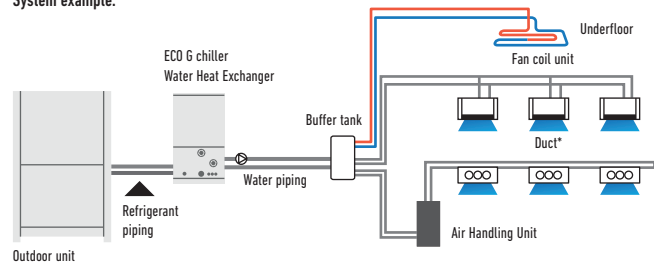

A Buffer tank of minimum 280l for 28kW and 500l for 50kW is always needed.

#### New electrical panel with new algorithm

- Optimized heat exchanger to increase drastically the efficiency
- Liquid receiver to outperform the functionality of the WHE
- Unique 4 way valve in order always have counterflow fluid circulation in heating and cooling fluid circulation on both sides of the cross flow. This optimizes efficiency!

Hydrokit with A class water pump*		PAW-250WX4E5N	PAW-500WX4E5N
Hydrokit without pump		PAW-250WX4E5N2	PAW-500WX4E5N2
Cooling capacity at 35°C, water outlet 7°C	kW	25,0	50,0
Heating capacity	kW	28,0	56,0
Heating capacity at +7°C, heating water temperature at 45°C	kW	28,0	56,0
COP at +7°C with heating water temperature at 45°C	W/W	2,97	3,10
Heating Energy Efficiency class at 35°C <sup>1)</sup>		A+	A+
ηsh (LOT21) <sup>2)</sup>	%	164,00	158,00
Dimension	HxWxD	1010x570x960	1010x570x960
Net weight	kg	120	145
Water pipe connector		Rp2 Female Thread (50A)	Rp2 Female Thread (50A)
Heating water flow (ΔT=5 K, 35°C)	m <sup>3</sup> /h	4,3	8,6
Capacity of integrated electric heater	kW	Not equipped	Not equipped
Input power	kW	0,01 + (min 0,05 / max 0,13 for water pump)	0,01 + (min 0,19 / max 0,31 for water pump)
Maximum current	A	0,07 + (min 0,37 / max 0,95 for water pump)	0,07 + (min 0,88 / max 1,37 for water pump)
<b>Outdoor Unit</b>		<b>U-10ME2E8</b>	<b>U-20ME2E8</b>
Sound pressure	dB(A)	59	63
Dimension	HxWxD	1758x770x930	1758x1540x930
Net weight	kg	234	421
Piping connections	Liquid pipe	Inch (mm)	3/8 (9,52)
	Gas pipe	Inch (mm)	7/8 (22,22)
Refrigerant (R410A)	kg	6,8 *Need Additional gas amount at site	9,0 *Need Additional gas amount at site
Pipe length range / Elevation difference (in/out)	m	170 / 50 (OD above) 35 (OD below)	170 / 50 (OD above) 35 (OD below)
Pipe length for nominal capacity	m	7,5	7,5
Pipe length for additional gas / Additional gas amount (R410A)	m / g/m	0 < / Refer to manual	0 < / Refer to manual
Operation range	Heat Min ~ Max	°C	-11 ~ +15 <sup>3)</sup>
Water outlet at 5 / 15 <sup>2)</sup>	°C	35 ~ 45	35 ~ 45

1) Unit efficiency energy level: Scale from A++ to G. 2) Seasonal space cooling/heating energy efficiency following COMMISSION REGULATION (EU) 813/2013. 3) With accessory low temperature kit -25 ~ +15°C.

\* PAW-250WX4E5N includes pump with 0-10 Volt Control by default / PAW-500WX4E5N includes pump with 0-10 Volt with optional I.F. Performance calculation in agreement with Eurovent. Sound pressure measured at 1m from the outdoor unit and at 1,5m height.



## 2-PIPE ECO G WITH WATER HEAT EXCHANGER FOR CHILLED AND HOT WATER PRODUCTION



### For hydronic applications

Water Heat Exchanger. Operation and control by timer remote control CZ-RTC5B. Energy-efficient capacity control. Stainless steel plate heat exchanger with anti-freeze protection control. Change-over between heating and cooling operation.

### Technical focus

- A class water pump included (only in N model)
- No cascade installation up to 80kW
- Water connections R2,5" f
- Maximum distance between outdoor units and WHE: 170m
- Possibility to mix DX and Water Heat Exchanger systems
- Silent outdoor units
- Hot water outlet temperatures from 35°C to 55°C
- Chilled water outlet temperatures from -15°C to +15°C
- Outdoor temperature range in cooling mode: -10°C to +43°C
- Minimum outdoor temperature in heating mode: -21°C

### Example of Hotel renewal of existing Chiller and Boiler system with Panasonic ECO G and Aquarea mixed solution.

ECO G and Aquarea are the smart solution for renewal Chiller/Boiler applications with annual running cost savings around 13.600€.

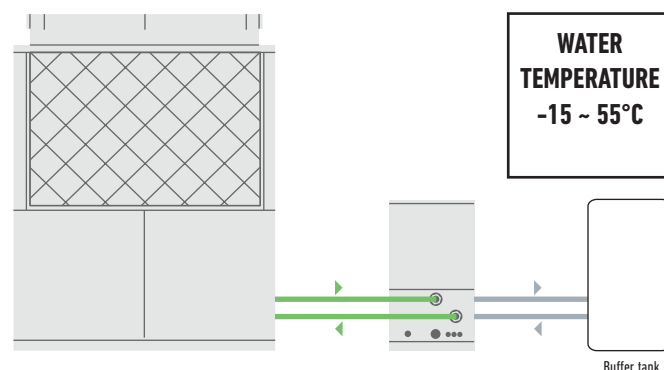

Hydrokit with A class water pump*		PAW-500WX4E5N	PAW-710WX4E5N
Hydrokit without pump		PAW-500WX4E5N2	PAW-710WX4E5N2
Heating Capacity	kW	60,00	80,00
Heating Capacity at +7°C, heating water temperature at 35°C	kW	60,90	81,20
COP at +7°C with heating water temperature at 35°C	W/W	1,15	1,18
Heating Capacity at +7°C, heating water temperature at 45°C	kW	60,00	80,00
COP at +7°C with heating water temperature at 45°C	W/W	1,02	1,04
Heating Capacity at -7°C, heating water temperature at 35°C	kW	48,20	50,80
COP at -7°C, heating water temperature at 35°C	W/W	0,80	0,80
Heating Capacity at -15°C, heating water temperature at 35°C	kW	46,30	50,00
COP at -15°C with heating water temperature at 35°C	W/W	0,80	0,80
Refrigeration load Pdesign	kW	48,00	—
<b>Heating Energy Efficiency class at 35°C<sup>1)</sup></b>		<b>A++</b>	—
$\eta_{sh}$ (LOT21) <sup>2)</sup>	%	<b>130,04</b>	—
Cooling capacity	kW	—	—
Cooling capacity at +35°C, outlet temperature 7°C, inlet temperature 12°C	kW	50	67
EER at +35°C, outlet temperature 7°C, inlet temperature 12°C	W/W	0,78	0,89
Dimension	H x W x D	1010 x 570 x 960	1010 x 570 x 960
Net weight	kg	145	180
Water pipe connector		—	—
Heating water flow ( $\Delta T=5$ K, 35°C)	m <sup>3</sup> /h	10,32	13,76
Capacity of integrated electric heater	kW	—	—
Input power	kW	—	—
Maximum current	A	—	—
<b>Outdoor Unit</b>		<b>U-20GE3E5</b>	<b>U-30GE3E5</b>
Sound power	Normal / Silent	83 / 80	84 / 81
Dimension / Net weight	H x W x D	2255 x 1650 x 1000 / 765	2255 x 2026 x 1000 / 880
Piping connections	Liquid pipe	Inch (mm)	5/8 (15,88)
	Gas pipe	Inch (mm)	1-1/8 (28,58)
Pipe length / for nominal capacity		m	7 / 170
Elevation difference (in/out)		m	50 (OD above) 35 (OD below)
Operation range	Heat Min ~ Max	°C	-21 - 24 (until outlet temperature 45)
Water outlet at-15 / 15		°C	35 - 55

1) Unit efficiency energy level: Scale from A++ to G. 2) Seasonal space cooling/heating energy efficiency following COMMISSION REGULATION (EU) 813/2013.

\* PAW-500WX4E5N and PAW-710WX4E5N includes pump with 0-10 Volt with optional IF. Performance calculation in agreement with Eurovent. Sound pressure measured at 1m from the outdoor unit and at 1,5m height.

# LEAK DETECTION AND AUTOMATIC REFRIGERANT PUMP DOWN



## Improving safety and the environment

Panasonic has developed an innovative solution to detect refrigerant leaks that offer complete assurance and protection for end users, building occupiers and the environment. Panasonic's Pump Down System is ideal for hotels, offices and public buildings where safety for occupants and the building owners is of utmost importance.

The system monitors refrigerant leakage continually and provides a warning before refrigerant leaks, preventing major refrigerant loss and potentially damaging the system's efficiency. The new system can improve potential refrigerant loss to approximately 90%.

As well as ensuring safe and reliable operation, Panasonic's Pump Down System contributes to a building qualifying for additional BREEAM points and enables compliance with current EN378 2008 standards, covering applications where refrigeration concentration levels exceed practical safety limits of 0,44 kg/m<sup>3</sup>.

Panasonic has developed two detection methods that can operate simultaneously to offer complete protection for owners, building occupiers and the environment.

## Pump Down system

**This innovative pump down system can be connected in two ways:**

- With sensor leakage
- Without sensor leakage, using only an innovative algorithm

### Basic pump down function:

- Detect the leakage
- Activate pump down process
- Collect the gas in the tank
- Close the valves to isolate the gas

### Key points:

- Comply with legislation
- Protect personnel
- Protect the environment
- Save on operating costs

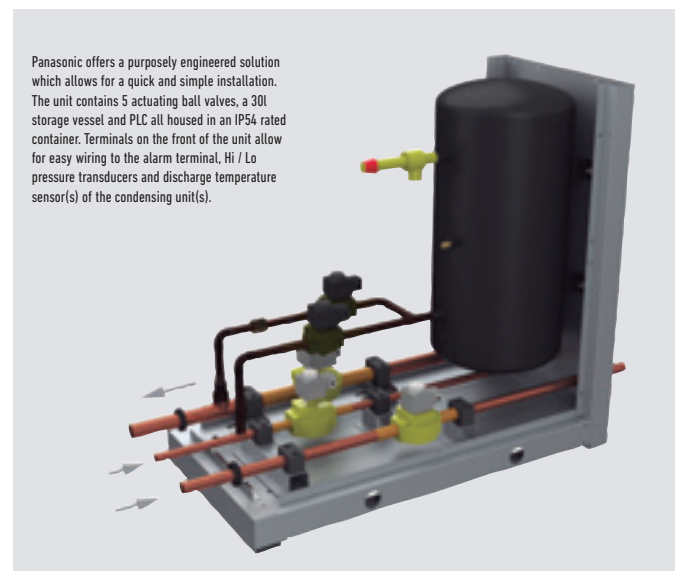

## R22 Renewal

Panasonic's advanced technology enables the system to work with previously installed pipe work by managing the working pressure within the system down to R22 (33 bar) levels, this ensures the system works safely and efficiently without loss of capacity.

The new equipment can offer increased COP/EER by using state of the art inverter compressor and heat exchanger technology.

Having contacted your Panasonic supplier regarding pipe work restrictions

and gained approval to use the Panasonic Renewal System there are three main tests that have to be carried out to ensure that the system can be used effectively. Firstly a thorough inspection of the pipe work must be carried out and any damage must be repaired. Secondly an oil test has to be carried out to ensure that the system has not been subject to a compressor burnout during its lifetime. Lastly a VRF Renewal Kit (CZ-SLK2) has to be installed within the pipe work to ensure that the system is cleaned of any remnants of oil.



# DESIGN SUPPORT SOFTWARE FOR VRF



Features the unique Mounting Scheme function providing more thorough spec-in and tender quotation support for easier, faster completion of work



**The Panasonic VRF Designer software can be used for all Panasonic VRF ME2, LE1 and MF2.**

Panasonic has identified the importance of ever-increasing demands for fast and accurate responses to customer requests in our industry. More and more emphasis is being placed upon energy-efficiency in our marketplace. The ability to calculate cooling/heating loads and produce information of actual design conditions is a major advantage to any architect, consultant, contractor or end user.

Panasonic understands the time-poor and demanding industry we are in and we are pleased to announce the launch of the next generation of our system design software program.

The Panasonic VRF Designer software has been customised to make the selection and design process as quick and easy as possible.

The design package utilises system wizards and import tools to enable both simple and complex systems to be created. In addition, the system will allow outdoor and indoor units to be dragged on an interactive desktop. This allows users to create everything from realistic floor plans with detailed piping and wiring schematics to send out with quotations, through to installation guidance drawings.

#### Features include:

- Mounting scheme. Design selection from building floor drawing
- Any kind of drawing format. (dxf, jpg, png..etc.)
- Conventional principal scheme
- Easy to use system wizards
- Auto piping and wiring features
- Converted duties for conditions and pipework
- Auto(CAD) (dxf), Excel and PDF export
- Detailed wiring and pipework diagrams
- Automatic price quotation
- Automatic tender document assist
- SEER, SCOP
- ESEER

**Panasonic's Advanced VRF software with AutoCAD® compatibility makes design easier than ever**

Panasonic provides bespoke software helping system designers, installers and dealers to very quickly design and size systems, create wiring diagrams and issue bills of quantities at the push of a button.



#### Panasonic VRF Service Checker

Panasonic will make available to installers and commissioning companies the VRF Service Checker as a communication interface to Panasonic VRF systems. This easy to manage tool checks all parameters of the system.

#### The VRF Service Checker allows:

- On ECOi and Mini ECOi connect anywhere on the P-Link
- Search the P-Link to validate systems that are connected
- Monitor all indoor and outdoor units simultaneously on 1 screen
- Monitor all Temperature data, Pressure data, Valve position, and alarm status on 1 screen
- Data can be viewed in Graph or number format
- Controlling the indoor unit ON/OFF, MODE, SET POINT, FAN, and TEST mode
- Switching between various systems on same communication P-Link (ECOi only)
- Monitor and record at a set interval time
- Record and review the data at a later date
- Update software as ROM flash writer

This Panasonic VRF Service Checker is available from your service partner.

















Interface Box







# NEW VRF SYSTEMS INDOOR UNITS





# ECOi AND ECO G SYSTEMS INDOOR UNITS RANGE

Page		1,5kW	2,2kW	2,8kW	3,0kW	3,6kW	4,0kW	4,5kW
P. 296	U2 Type 4 Way 90x90 Cassette							
			S-22MU2E5A	S-28MU2E5A		S-36MU2E5A		S-45MU2E5A
P. 298	Y2 Type 4 Way 60x60 Cassette							
		S-15MY2E5A	S-22MY2E5A	S-28MY2E5A		S-36MY2E5A		S-45MY2E5A
P. 299	L1 Type 2 Way Cassette							
			S-22ML1E5	S-28ML1E5		S-36ML1E5		S-45ML1E5
P. 300	D1 Type 1 Way Cassette							
				S-28MD1E5		S-36MD1E5		S-45MD1E5
P. 301	F2 Type Variable Static Pressure Hide Away							
		S-15MF2E5A	S-22MF2E5A	S-28MF2E5A		S-36MF2E5A		S-45MF2E5A
P. 302	M1 Type Slim Variable Static Pressure Hide Away							
		S-15MM1E5A	S-22MM1E5A	S-28MM1E5A		S-36MM1E5A		S-45MM1E5A
P. 303	E2 Type High Static Pressure Hide Away							
P. 304	Heat Recovery with DX Coil							
					PAW-500ZDX3N	PAW-800ZDX3N	PAW-01KZDX3N	
P. 305	T2 Type Ceiling							
						S-36MT2E5A	S-45MT2E5A	
P. 306	K2 Type Wall Mounted							
		S-15MK2E5A	S-22MK2E5A	S-28MK2E5A		S-36MK2E5A		S-45MK2E5A
P. 307	P1 Type Floor Standing							
			S-22MP1E5	S-28MP1E5		S-36MP1E5		S-45MP1E5
P. 308	R1 Type Concealed Floor Standing							
			S-22MR1E5	S-28MR1E5				S-45MR1E5
P. 309	Hydrokit for ECOi, water at 45°C							

Page		16,0kW	28,0kW	56,0kW	84,0kW	112,0kW	140,0kW	168,0kW
P. 314	AHU Connection Kit 16, 28 and 56kW							
		PAW-160MAH2/M/L	PAW-280MAH2/M/L	PAW-560MAH2/M/L	PAW-280MAH2/M/L + PAW-560MAH2/M/L	PAW-560MAH2/M/L x 2	PAW-280MAH2/M/L + PAW-560MAH2/M/L x 2	PAW-560MAH2/M/L x 3

Page		250m <sup>3</sup> /h	350m <sup>3</sup> /h	500m <sup>3</sup> /h	800m <sup>3</sup> /h	1000m <sup>3</sup> /h
P. 318	Energy Recovery Ventilation					
		FY-250ZDY8R	FY-350ZDY8R	FY-500ZDY8R	FY-800ZDY8R	FY-01KZDY8R

5,6kW      6,0kW      7,3kW      9,0kW      10,6kW      14,0kW      16,0kW      22,4kW      28,0kW



S-56MU2E5A    S-60MU2E5A    S-73MU2E5A    S-90MU2E5A    S-106MU2E5A    S-140MU2E5A    S-160MU2E5A



S-56MY2E5A



S-56ML1E5



S-73ML1E5



S-56MD1E5



S-73MD1E5



S-56MF2E5A    S-60MF2E5A    S-73MF2E5A    S-90MF2E5A    S-106MF2E5A    S-140MF2E5A    S-160MF2E5A



S-56MM1E5A



S-224ME2E5



S-280ME2E5



S-56MT2E5A



S-73MT2E5A



S-106MT2E5A



S-140MT2E5A

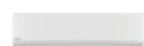

S-56MK2E5A

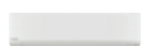

S-73MK2E5A



S-106MK2E5A



S-56MP1E5



S-71MP1E5



S-56MR1E5



S-71MR1E5



S-80MW1E5



S-125MW1E5

Page

11,4kW

25,0kW

31,5kW

37,5kW

P. 316

Air Curtain Jet-Flow with DX Coil



PAW-10EAIRC-MJ



PAW-15EAIRC-MJ



PAW-20EAIRC-MJ



PAW-25EAIRC-MJ

P. 316

Air Curtain Standard with DX Coil



PAW-10EAIRC-MS



PAW-20EAIRC-MS

## U2 TYPE 4 WAY 90x90 CASSETTE

Large capacity VRF. Trusted power and high efficiency. These cassettes offer upgraded Econavi and nanoe™ X purification system as accessories for making application space more comfortable, healthy and efficient.

Thanks to advances in design and technology such as the new high performance turbo fan, more efficient and silent, the nanoe™ X air cleaner, for total healthy and the floor temperature & humidity sensor to more control, the new U2 Panasonic 4 Way 90x90 Cassette offers healthy and comfort.

### Always fresh and clean air with nanoe™ X

New nanoe™ X is available by the advanced technology of room air conditioning.

- Purificating operation can work simultaneously or independently from heating/cooling operation.
- Inhibiting certain viruses, bacteria & deodorisation (bacteria, fungus, pollen, virus and cigarette smoke). OH radicals in nanoe™ X pull bacteria's hydrogen out and it is effectively deodorised and sterilised
- Clean inside by nanoe™ X + Dry control: inside of indoor unit can be cleaned by short operation circuit with nanoe™ X and drying

CZ-RTC5B and optional accessory CZ-CNEXU1 are required to use nanoe™ X function.



### Econavi intelligent sensor

Human activity sensor and floor temperature sensor can reduce waste of energy by optimising air conditioner operation.



#### Advanced Econavi functions.

2 sensors (movement and floor temperature) can find waste of energy and control effectively. Floor temperature can detect up to 5m ceiling height.

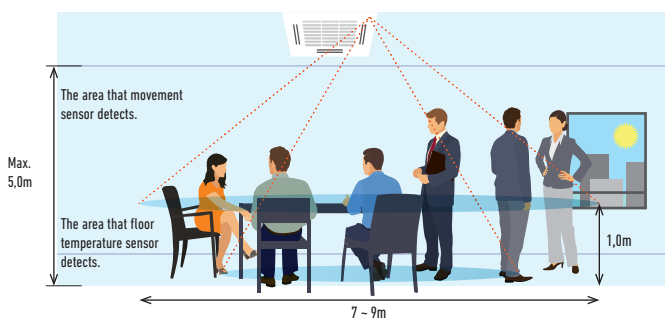

**Econavi exclusive panel. Optional (CZ-KPU3A)**

**Floor temperature sensor.**  
This sensor detects average floor temperature and operates circulation if floor is low temperature.

**Movement sensor.**  
This sensor detects the amount of human activity, and operates effectively.

Wired remote controller CZ-RTC5B is required.

### Humidity sensor.

New humidity sensor has added on air suction part, and realises comfort and energy saving based on temperature and humidity.

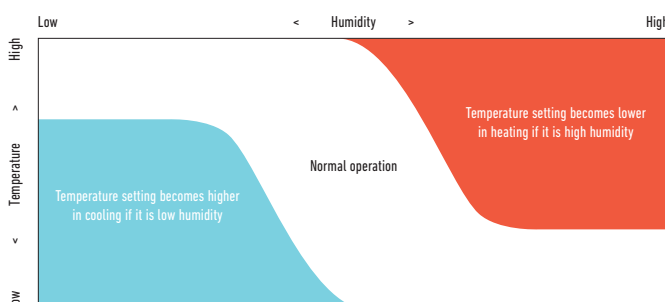

### Group control, circulation function.

Circulating operation is activated when nobody is there, and mix air in the whole room. Minimize temperature gap in both heating and cooling operation.

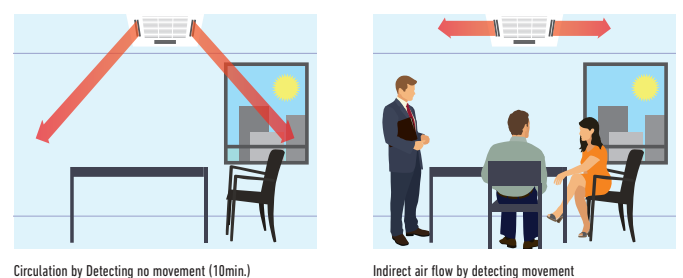



ECOi and ECO G Systems Indoor units



The new U2 Panasonic 4 Way 90x90 Cassettes with new panel design and 2 types of body with height difference.

Technical focus

- New high performance turbo fan, new path system for heat exchanger
- Lower noise in slow fan operation
- Ceiling height up to 5,0m
- Industry top light weight, easy piping
- Econavi: Floor temperature and humidity sensor added. Activity amount detection and new circulator
- nanoe™ X: The first 10x for CAC (10 times more purification power). Inside cleaning by 10x nanoe™ X + dry control
- Powerful drain pump gives 850mm lift
- Fresh air knockout
- Branch duct connection
- Optional air-intake plenum CZ-FDU2

2 types of body with height difference (same as current ones)

25,6cm and 31,9cm.

Panasonic introduces new flat panel design which is modern and matching well with your space. These cassettes have developed to satisfy today's customer needs such as high energy saving, comfort and healthier air.

The drain pipe can be raised to a maximum height of 850mm from the bottom of the ceiling

Do not attempt to raise it higher than 850mm. Doing so will result in water leakage.

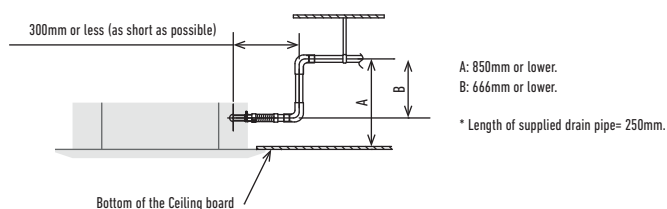

New Panel design

Flat design, well-matched with interior, building. Position of 4 air wings can be set individually.



Model		S-22MU2E5A	S-28MU2E5A	S-36MU2E5A	S-45MU2E5A	S-56MU2E5A	S-60MU2E5A	S-73MU2E5A	S-90MU2E5A	S-106MU2E5A	S-140MU2E5A	S-160MU2E5A
Cooling capacity	kW	2,20	2,80	3,60	4,50	5,60	6,00	7,30	9,00	10,60	14,00	16,00
Input power cooling	W	20,00	20,00	20,00	20,00	25,00	35,00	40,00	40,00	95,00	100,00	115,00
Current (cool)	A	0,19	0,19	0,19	0,19	0,22	0,31	0,33	0,36	0,71	0,76	0,89
Heating capacity	kW	2,50	3,20	4,20	5,00	6,30	7,10	8,00	10,00	11,40	16,00	18,00
Input power heating	W	20,00	20,00	20,00	20,00	25,00	35,00	40,00	40,00	85,00	100,00	105,00
Current (heat)	A	0,17	0,17	0,17	0,17	0,20	0,30	0,32	0,34	0,65	0,73	0,80
Fan type		Turbo fan	Turbo fan	Turbo fan	Turbo fan	Turbo fan	Turbo fan	Turbo fan	Turbo fan	Turbo fan	Turbo fan	Turbo fan
Air volume	Hi / Med / Lo m <sup>3</sup> /min	14,50 / 13,00 / 11,50	14,50 / 13,00 / 11,50	14,50 / 13,00 / 11,50	15,50 / 13,00 / 11,50	17,00 / 13,50 / 11,50	21,00 / 16,00 / 13,00	22,50 / 16,00 / 13,00	23,00 / 18,50 / 14,00	35,00 / 26,00 / 20,00	36,00 / 27,00 / 21,50	37,00 / 29,00 / 25,00
Sound pressure	Hi / Med / Lo dB(A)	30 / 29 / 28	30 / 29 / 28	30 / 29 / 28	31 / 29 / 28	33 / 30 / 28	36 / 32 / 29	37 / 32 / 29	38 / 35 / 32	44 / 38 / 34	45 / 39 / 35	46 / 40 / 38
Sound power	Hi / Med / Lo dB	45 / 44 / 43	45 / 44 / 43	45 / 44 / 43	46 / 44 / 43	48 / 45 / 43	51 / 47 / 44	52 / 47 / 44	53 / 50 / 47	59 / 53 / 49	60 / 54 / 50	61 / 55 / 53
Dimension (HxWxD)	Indoor mm	256x840x840	256x840x840	256x840x840	256x840x840	256x840x840	256x840x840	256x840x840	256x840x840	319x840x840	319x840x840	319x840x840
	Panel mm	33,5x950x950	33,5x950x950	33,5x950x950	33,5x950x950	33,5x950x950	33,5x950x950	33,5x950x950	33,5x950x950	33,5x950x950	33,5x950x950	33,5x950x950
Net weight (Panel)	kg	21 (5)	21 (5)	21 (5)	21 (5)	21 (5)	21 (5)	21 (5)	21 (5)	25 (5)	25 (5)	25 (5)
Piping connections	Liquid Inch (mm)	1/4 (6,35)	1/4 (6,35)	1/4 (6,35)	1/4 (6,35)	1/4 (6,35)	3/8 (9,52)	3/8 (9,52)	3/8 (9,52)	3/8 (9,52)	3/8 (9,52)	3/8 (9,52)
	Gas Inch (mm)	1/2 (12,70)	1/2 (12,70)	1/2 (12,70)	1/2 (12,70)	1/2 (12,70)	5/8 (15,88)	5/8 (15,88)	5/8 (15,88)	5/8 (15,88)	5/8 (15,88)	5/8 (15,88)

\* Sound pressure with no refrigerant flow.



ECONAVI AND INTERNET CONTROL: Optional.



## Y2 TYPE 4 WAY 60x60 CASSETTE



Designed to fit exactly into a 600 x 600mm ceiling grid without the need to alter the bar configuration, the Y2 is ideal for small commercial and retrofit applications. In addition, the improvements to efficiency make this one of the most advanced units in the industry.

### Technical focus

- Mini cassette fits into a 600 x 600mm ceiling grid
- Fresh air knock out
- Multidirectional airflow
- Powerful drain pump gives 850mm lift
- Turbo fans and heat exchanger fins with improved design
- DC-Fan motors with variable speed, new heat exchangers, etc. ensure an efficient power consumption

### A drain height of approximately 850mm from the ceiling surface

The drain height can be increased by approximately 350mm over the conventional value by using a high-lift drain pump, and long horizontal piping is possible.

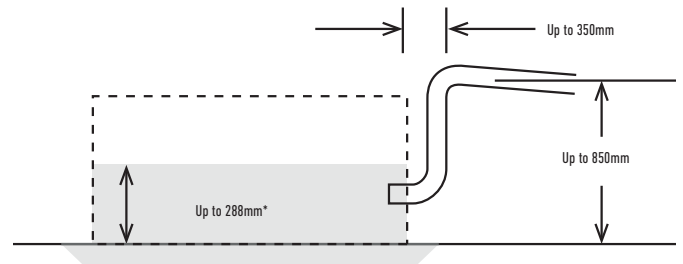

A lightweight unit at 18,4kg the unit is also very slim with a height of only 288mm, making installation possible even in narrow ceilings.



Optional Controller. Control for hotel application PAW-RE2C3



Optional Controller. Wired remote controller CZ-RTCSB Compatible with Econavi and datanavi



Optional Econavi Sensor. CZ-CENSC1



Optional Controller. Wireless remote controller CZ-RWSK2



Optional Controller. Simplified remote controller CZ-RE2C2

Model <sup>1</sup>		S-15MY2E5A	S-22MY2E5A	S-28MY2E5A	S-36MY2E5A	S-45MY2E5A	S-56MY2E5A	
Cooling capacity	kW	1,50	2,20	2,80	3,60	4,50	5,60	
Input power cooling	W	35,00	35,00	35,00	40,00	40,00	45,00	
Operating current cooling	A	0,30	0,30	0,30	0,30	0,32	0,35	
Heating capacity	kW	1,70	2,50	3,20	4,20	5,00	6,30	
Input power heating	W	30,00	30,00	30,00	35,00	35,00	40,00	
Operating current heating	A	0,25	0,25	0,30	0,30	0,30	0,30	
Fan type		Centrifugal fan	Centrifugal fan	Centrifugal fan	Centrifugal fan	Centrifugal fan	Centrifugal fan	
Air volume	Cooling	m <sup>3</sup> /min	8,90 / 8,20 / 5,60	9,10 / 8,20 / 5,60	9,30 / 8,40 / 5,60	9,70 / 8,70 / 6,00	10,00 / 9,30 / 8,20	10,40 / 9,80 / 8,50
	Heating	m <sup>3</sup> /min	9,10 / 8,40 / 5,60	9,30 / 8,40 / 5,60	9,60 / 8,70 / 5,60	9,90 / 9,10 / 6,00	10,30 / 9,60 / 8,20	11,10 / 9,80 / 8,70
Sound pressure	Hi / Med / Lo	dB(A)	34 / 31 / 25	35 / 31 / 25	35 / 31 / 25	36 / 32 / 26	38 / 34 / 28	40 / 37 / 34
Sound power	Hi / Med / Lo	dB	49 / 46 / 40	50 / 46 / 40	50 / 46 / 40	51 / 47 / 41	53 / 49 / 43	55 / 52 / 49
Dimension (HxWxD)	Indoor	mm	288 x 583 x 583	288 x 583 x 583	288 x 583 x 583	288 x 583 x 583	288 x 583 x 583	288 x 583 x 583
	Panel 3A	mm	31 x 700 x 700	31 x 700 x 700	31 x 700 x 700	31 x 700 x 700	31 x 700 x 700	31 x 700 x 700
	Panel 3B	mm	31 x 625 x 625	31 x 625 x 625	31 x 625 x 625	31 x 625 x 625	31 x 625 x 625	31 x 625 x 625
Net weight		kg	20,4 (18 + 2,4)	20,4 (18 + 2,4)	20,4 (18 + 2,4)	20,4 (18 + 2,4)	20,4 (18 + 2,4)	20,4 (18 + 2,4)
Piping connections	Liquid pipe	Inch (mm)	1/4 (6,35)	1/4 (6,35)	1/4 (6,35)	1/4 (6,35)	1/4 (6,35)	1/4 (6,35)
	Gas pipe	Inch (mm)	1/2 (12,70)	1/2 (12,70)	1/2 (12,70)	1/2 (12,70)	1/2 (12,70)	1/2 (12,70)



ECONAVI and INTERNET CONTROL: Optional.



Panel CZ-KPY3AW (size 700 x 700mm) CZ-KPY3BW (size 625 x 625mm)

# L1 TYPE 2 WAY CASSETTE

Slim, compact and lightweight units. Remarkable size and weight reductions have been achieved by improvement of the design around the fan, the weight of all models now being 30kg.

### Technical focus

- Airflow and distribution is automatically altered depending on the operational mode of the unit
- Drain up is possible up to 500mm from the drain port
- Simple maintenance

### Simple maintenance

The drain pan is equipped with site wiring and can be removed. The fan case has a split construction, and the fan motor can be removed easily when the lower case is removed.



### Auto flap control

Airflow and distribution is automatically altered depending on the operational mode of the unit.

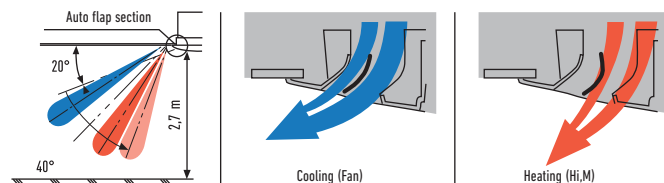

### Drain up is possible up to 500mm from the drain port

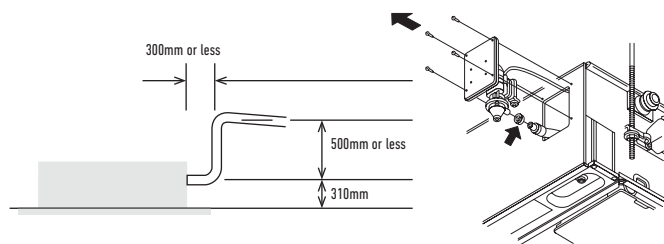

Maintenance of the drain pump is possible from two sides, from the left side (piping side) and from the inside of the unit.



Optional Controller. Control for hotel application PAW-RE2C3



Optional Controller. Wired remote controller CZ-RTCSB Compatible with Econavi and datanavi



Optional Econavi Sensor. CZ-CENS1



Optional Controller. Wireless remote controller CZ-RWSL2N



Optional Controller. Simplified remote controller CZ-RE2C2

Model		S-22ML1E5	S-28ML1E5	S-36ML1E5	S-45ML1E5	S-56ML1E5	S-73ML1E5
Cooling capacity	kW	2,20	2,80	3,60	4,50	5,60	7,30
Input power cooling	W	90,00	92,00	93,00	97,00	97,00	145,00
Operating current cooling	A	0,45	0,45	0,45	0,45	0,45	0,65
Heating capacity	kW	2,50	3,20	4,20	5,00	6,30	8,00
Input power heating	W	58,00	60,00	61,00	65,00	65,00	109,00
Operating current heating	A	0,29	0,29	0,29	0,29	0,29	0,48
Fan type		Sirocco fan	Sirocco fan	Sirocco fan	Sirocco fan	Sirocco fan	Sirocco fan
Air volume	Hi / Med / Lo	m <sup>3</sup> /min	8,00 / 7,00 / 6,00	9,00 / 8,00 / 7,00	9,70 / 8,70 / 7,70	11,00 / 9,00 / 8,00	19,00 / 16,00 / 14,00
Sound pressure	Hi / Med / Lo	dB(A)	30 / 27 / 24	33 / 29 / 26	34 / 31 / 28	35 / 33 / 29	38 / 35 / 33
Dimension (HxWxD)	Indoor	mm	350x840x600	350x840x600	350x840x600	350x840x600	350x1140x600
	Panel	mm	8x1060x680	8x1060x680	8x1060x680	8x1060x680	8x1360x680
Net weight (Panel)		kg	23(5,5)	23(5,5)	23(5,5)	23(5,5)	30(9)
Piping connections	Liquid pipe	Inch (mm)	1/4 (6,35)	1/4 (6,35)	1/4 (6,35)	1/4 (6,35)	3/8 (9,52)
	Gas pipe	Inch (mm)	1/2 (12,70)	1/2 (12,70)	1/2 (12,70)	1/2 (12,70)	5/8 (15,88)



ECONAVI and INTERNET CONTROL: Optional.



Panel CZ-02KPL2 CZ-03KPL2 (for S-73ML1E5)

# D1 TYPE 1 WAY CASSETTE



Designed for installation within the ceiling void, the D1 range of slimline 1 way blow cassettes feature powerful yet quiet fans for up to 4,2m.

### Technical focus

- Ultra-Slim
- Suitable for standard and high ceilings
- Built-in drain pump provides 590mm lift
- Easy to install and maintain
- Hanging height can be easily adjusted
- Uses a DC-Fan motor to improve energy-efficiency

### Drain height

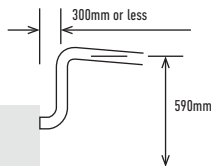

With 3 types of air-blow systems, the units can be used in various ways



**1. One-direction "down-blow" system.**  
Powerful one-direction "down-blow" system reaches the floor even from high ceilings (up to 4,2m).



**2. Two-direction ceiling-mounted system.**  
"Down-blow" and "front-blow" systems are combined in a ceiling-mounted unit to blow air over a wide area.



**3. One-direction ceiling-mounted system.**  
This powerful ceiling-mounted "front-blow" system efficiently air-conditions the space in front of the unit. (Additional accessories required)



Optional Controller. Control for hotel application PAW-RE2C3



Optional Controller. Wired remote controller CZ-RTCSB Compatible with Econavi and datanavi



Optional Econavi Sensor. CZ-CENSC1



Optional Controller. Wireless remote controller CZ-RWSD2



Optional Controller. Simplified remote controller CZ-RE2C2

Model		S-28MD1E5	S-36MD1E5	S-45MD1E5	S-56MD1E5	S-73MD1E5
Cooling capacity	kW	2,80	3,60	4,50	5,60	7,30
Input power cooling	W	51,00	51,00	51,00	60,00	87,00
Operating current cooling	A	0,39	0,39	0,39	0,46	0,70
Heating capacity	kW	3,20	4,20	5,00	6,30	8,00
Input power heating	W	40,00	40,00	40,00	48,00	76,00
Operating current heating	A	0,35	0,35	0,35	0,41	0,65
Fan type		Sirocco fan	Sirocco fan	Sirocco fan	Sirocco fan	Sirocco fan
Air volume	Hi / Med / Lo m <sup>3</sup> /min	12,00 / 10,00 / 9,00	12,00 / 10,00 / 9,00	12,00 / 11,00 / 10,00	13,00 / 11,50 / 10,00	18,00 / 15,00 / 13,00
Sound pressure	Hi / Med / Lo dB(A)	36 / 34 / 33	36 / 34 / 33	36 / 35 / 34	38 / 36 / 34	45 / 40 / 36
Dimension (HxWxD)	Indoor mm	200x1000x710	200x1000x710	200x1000x710	200x1000x710	200x1000x710
	Panel mm	20x1230x800	20x1230x800	20x1230x800	20x1230x800	20x1230x800
Net weight (Panel)	kg	21 (5,5)	21 (5,5)	21 (5,5)	21 (5,5)	22 (5,5)
Piping connections	Liquid pipe Inch (mm)	1/4 (6,35)	1/4 (6,35)	1/4 (6,35)	1/4 (6,35)	3/8 (9,52)
	Gas pipe Inch (mm)	1/2 (12,70)	1/2 (12,70)	1/2 (12,70)	1/2 (12,70)	5/8 (15,88)



ECONAVI and INTERNET CONTROL: Optional.



Panel CZ-KPD2

ECOi and ECO G Systems Indoor units

## F2 TYPE VARIABLE STATIC PRESSURE HIDE AWAY

The new F2 type is designed specifically for applications requiring fixed square ducting. The internal filter is equipped as standard.

### Technical focus

- Industry-leading low sound levels from 25dB(A)
- Built-in drain pump provides 785mm lift
- Easy to install and maintain
- Air OFF sensor avoids cold air dumping
- Configurable air temperature control

### More powerful drain pump

Using a high-lift drain pump, drain piping can be elevated up to 785mm from the base of the unit.

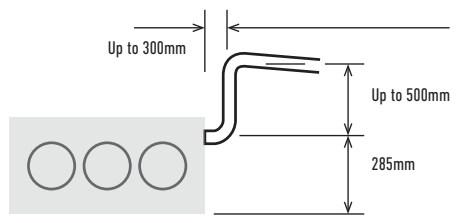

### F2 Advantages

Automatic learning function for the required static pressure, to be activated easily by the standard wired timer remote controller. Possible to increase the sensible cooling capacity by adjusting the air volume flow in order to almost completely eliminate latent losses. This is possible due to the outstanding big heat exchanger surface in combination with increasing the air volume flow by a manual selection of higher fan speed curves through the standard wired remote controller when commissioning the system together with the default active off-coil temperature control and the room load based variable evaporation temperature control.

Diagram 1 S-22MF2E5A

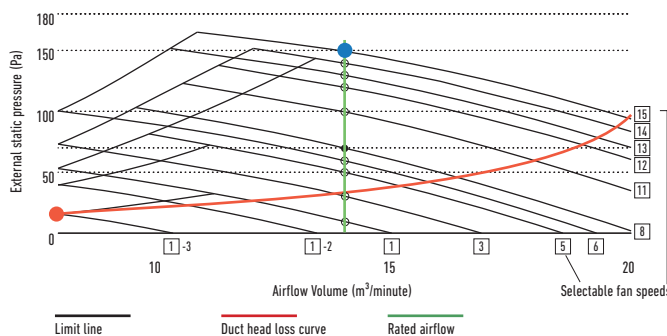

Model	S-15MF2E5A	S-22MF2E5A	S-28MF2E5A	S-36MF2E5A	S-45MF2E5A	S-56MF2E5A	S-60MF2E5A	S-73MF2E5A	S-90MF2E5A	S-106MF2E5A	S-140MF2E5A	S-160MF2E5A	
Cooling capacity	kW 1,50	2,20	2,80	3,60	4,50	5,60	6,00	7,30	9,00	10,60	14,00	16,00	
Input power cooling	W 70,00	70,00	70,00	70,00	70,00	100,00	120,00	120,00	135,00	195,00	215,00	225,00	
Current (cool)	A 0,57	0,57	0,57	0,57	0,57	0,74	0,89	0,89	0,97	1,30	1,44	1,50	
Heating capacity	kW 1,70	2,50	3,20	4,20	5,00	6,30	7,10	8,00	10,00	11,40	16,00	18,00	
Input power heating	W 70,00	70,00	70,00	70,00	70,00	100,00	120,00	120,00	135,00	200,00	210,00	225,00	
Current (heat)	A 0,57	0,57	0,57	0,57	0,57	0,74	0,89	0,89	0,97	1,34	1,42	1,50	
Fan type	Sirocco fan												
Air volume <sup>1</sup>	Hi / Med / Lo	14,00/13,00/ 9,00	14,00/13,00/ 9,00	14,00/13,00/ 9,00	14,00/13,00/ 9,00	14,00/13,00/ 10,00	16,00/15,00/ 12,00	21,00/19,00/ 15,00	21,00/19,00/ 15,00	25,00/23,00/ 19,00	32,00/26,00/ 21,00	34,00/29,00/ 23,00	36,00/32,00/ 25,00
External static pressure	Pa	70 (10-150)	70 (10-150)	70 (10-150)	70 (10-150)	70 (10-150)	70 (10-150)	70 (10-150)	70 (10-150)	70 (10-150)	100 (10-150)	100 (10-150)	
Sound pressure <sup>2</sup>	Hi / Med / Lo	33 / 29 / 22	33 / 29 / 22	33 / 29 / 22	33 / 29 / 22	34 / 32 / 25	34 / 32 / 25	35 / 32 / 26	35 / 32 / 26	37 / 34 / 28	38 / 34 / 31	39 / 35 / 32	40 / 36 / 33
Sound power <sup>2</sup>	Hi / Med / Lo	55 / 51 / 44	55 / 51 / 44	55 / 51 / 44	55 / 51 / 44	56 / 54 / 47	56 / 54 / 47	57 / 54 / 48	57 / 54 / 48	59 / 56 / 50	60 / 56 / 53	61 / 57 / 54	62 / 58 / 55
Dimension	H x W x D	290 x 800 x 700	290 x 800 x 700	290 x 800 x 700	290 x 800 x 700	290 x 800 x 700	290 x 800 x 700	290 x 1000 x 700	290 x 1000 x 700	290 x 1000 x 700	290 x 1400 x 700	290 x 1400 x 700	290 x 1400 x 700
Net weight	kg	29	29	29	29	29	29	34	34	34	46	46	46
Piping connections	Liquid / Gas	Inch (mm) 1/4 (6,35) / 1/2 (12,70)	1/4 (6,35) / 1/2 (12,70)	1/4 (6,35) / 1/2 (12,70)	1/4 (6,35) / 1/2 (12,70)	1/4 (6,35) / 1/2 (12,70)	1/4 (6,35) / 1/2 (12,70)	3/8 (9,52) / 5/8 (15,88)	3/8 (9,52) / 5/8 (15,88)	3/8 (9,52) / 5/8 (15,88)	3/8 (9,52) / 5/8 (15,88)	3/8 (9,52) / 5/8 (15,88)	3/8 (9,52) / 5/8 (15,88)

1) Value referred to standard settings at shipment (H curve 8, M curve 5, L curve 1). 2) Sound pressure without refrigerant flow.



ECONAVI and INTERNET CONTROL: Optional.

# M1 TYPE SLIM VARIABLE STATIC PRESSURE HIDE AWAY CONCEALED DUCT

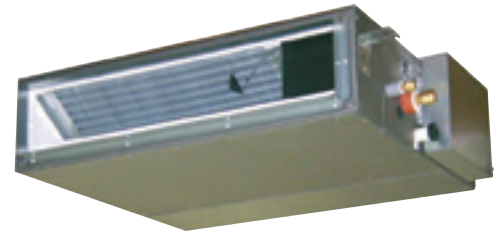

The ultra slim M1 type is one of the leading products of its type in the industry. With a depth of only 200mm it provides greater flexibility and can be used in far more applications. In addition, its high-efficiency and extremely quiet sound levels make it very popular with many users, including hotels and small offices.

### Ultra-slim profile for all models

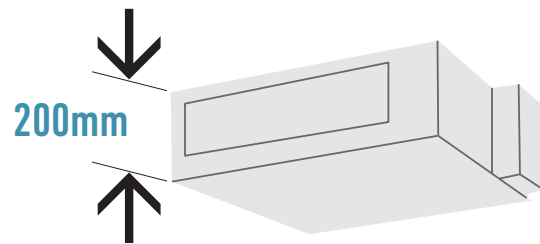

### Technical focus

- Ultra-slim profile: 200mm for all models
- DC-Fan motor greatly reduces power consumption
- Ideal for hotel application with very narrow false ceilings
- Easy maintenance and service by external electrical box
- 40Pa static pressure enables ductwork to be fitted.
- Includes drain pump

### Drain pump with increased power!

By adoption of a high-lift drain pump, the drain piping rise height can be increased to 785mm from the lower surface of the body.

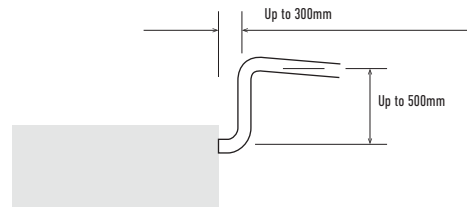

### Air Outlet & Inlet Plenum

S-...MM1E5A	Diameters	Air Outlet Plenum	Diameters	Air Inlet Plenum
22, 28 & 36	2 x Ø200	CZ-DUMPA22MMS2	2 x Ø200	CZ-DUMPA22MMR2
45 & 56	3 x Ø160	CZ-DUMPA45MMS3	2 x Ø200	CZ-DUMPA22MMR3



Optional Controller. Control for hotel application PAW-RE2C3



Optional Controller. Wired remote controller CZ-RTCSB Compatible with Econavi and datanavi



Optional Econavi Sensor. CZ-CENSC1



Optional Controller. Wireless remote controller CZ-RWSK3 + CZ-RWSC3



Optional Controller. Simplified remote controller CZ-RE2C2

Model		S-15MM1E5A	S-22MM1E5A	S-28MM1E5A	S-36MM1E5A	S-45MM1E5A	S-56MM1E5A	
Cooling capacity	kW	1,50	2,20	2,80	3,60	4,50	5,60	
Input power cooling	W	36,00	36,00	40,00	42,00	49,00	64,00	
Operating current cooling	A	0,26	0,26	0,30	0,31	0,37	0,48	
Heating capacity	kW	1,70	2,50	3,20	4,20	5,00	6,30	
Input power heating	W	26,00	26,00	30,00	32,00	39,00	54,00	
Operating current heating	A	0,23	0,23	0,27	0,28	0,34	0,45	
Fan type		Sirocco fan	Sirocco fan	Sirocco fan	Sirocco fan	Sirocco fan	Sirocco fan	
Air volume	Hi / Med / Lo	m <sup>3</sup> /min	8,00 / 7,00 / 6,00	8,00 / 7,00 / 6,00	8,50 / 7,50 / 6,50	9,00 / 8,00 / 7,00	10,50 / 9,50 / 8,00	12,50 / 11,50 / 10,00
External static pressure		Pa	10 (30)	10 (30)	15 (30)	15 (40)	15 (40)	
Sound pressure	Hi / Med / Lo <sup>1)</sup>	dB(A)	28 / 27 / 25 (30 / 29 / 27)	28 / 27 / 25 (30 / 29 / 27)	30 / 29 / 27 (32 / 31 / 29)	32 / 30 / 28 (34 / 32 / 30)	34 / 32 / 30 (36 / 34 / 32)	35 / 33 / 31 (37 / 35 / 32)
Sound power	Hi / Med / Lo	dB	43 / 42 / 40	43 / 42 / 40	45 / 44 / 42	47 / 45 / 43	49 / 47 / 45	50 / 48 / 46
Dimension	H x W x D	mm	200 x 750 x 640	200 x 750 x 640	200 x 750 x 640	200 x 750 x 640	200 x 750 x 640	
Net weight		kg	19	19	19	19	19	
Piping connections	Liquid pipe	Inch (mm)	1/4 (6,35)	1/4 (6,35)	1/4 (6,35)	1/4 (6,35)	1/4 (6,35)	
	Gas pipe	Inch (mm)	1/2 (12,70)	1/2 (12,70)	1/2 (12,70)	1/2 (12,70)	1/2 (12,70)	

1) With booster cable using short circuit connection.



ECONAVI and INTERNET CONTROL: Optional.

## E2 TYPE HIGH STATIC PRESSURE HIDE AWAY

High pressure duct and 100% Fresh air duct function. The E2 range of ducted units offers improved design flexibility for extended duct layouts as a result of their increased external static pressures and reduces energy consumption.

### Technical focus

- No need of rap valve
- 100% Fresh air duct function
- DC-Fan motor for more savings
- Complete flexibility for ductwork design
- Can be located into a weatherproof housing for external sitting
- Air OFF sensor avoids cold air dumping
- Configurable air temperature control

### System example

An inspection port (450 x 450mm or more) is required at the lower side of the indoor unit body (field supply).

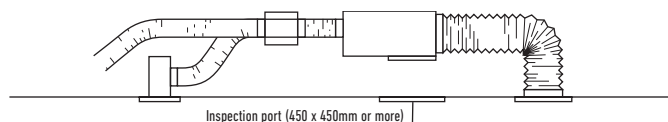

Optional Controller.  
Control for hotel  
application  
PAW-RE2C3



Optional Controller.  
Wired remote  
controller CZ-RTCSB  
Compatible with  
Econavi and datanavi



Optional Econavi  
Sensor.  
CZ-CENSC1



Optional Controller.  
Wireless remote  
controller CZ-RWSK2  
+ CZ-RWSC3



Optional Controller.  
Simplified remote  
controller CZ-RE2C2

Model	100% Fresh air duct function (by using Kit for 100% Fresh air)				High pressure duct				
	S-224ME2E5		S-280ME2E5		S-224ME2E5		S-280ME2E5		
		Cooling	Heating	Cooling	Heating	Cooling	Heating	Cooling	Heating
Capacity	kW	22,40	21,20	28,00	26,50	22,40	25,00	28,00	31,50
Input power	W	290,00	290,00	350,00	350,00	440,00	440,00	715,00	715,00
Operating current	A	1,85	1,85	2,20	2,20	2,45	2,45	3,95	3,95
Air volume	Hi / Med / Lo	m <sup>3</sup> /min		35,00 / — / —		56,00 / 51,00 / 44,00		72,00 / 63,00 / 53,00	
External static pressure	Pa	200		200		140(60 - 270) <sup>1</sup>		140(72 - 270) <sup>1</sup>	
Sound pressure <sup>2</sup>	Hi / Med / Lo	dB(A)		44 / — / —		45 / 43 / 41		49 / 47 / 43	
Sound power	Hi / Med / Lo	dB		76 / — / —		77 / 75 / 73		81 / 79 / 75	
Dimension	HxWxD	mm		479 x 1453 x 1205		479 x 1453 x 1205		479 x 1453 x 1205	
Net weight	kg	102		106		102		106	
Piping connections	Liquid pipe	Inch (mm)		3/8 (9,52)		3/8 (9,52)		3/8 (9,52)	
	Gas pipe	Inch (mm)		7/8 (22,22)		3/4 (19,05)		7/8 (22,22)	

Rating Conditions for 100% Fresh air duct function: Cooling Outdoor 33°C DB / 28°C WB. Heating Outdoor 0°C DB / -2.9°C WB. 1) Available to select the setting by initial setup. 2) Values with 140Pa setting. \* No filter included. No compatible with 3-Pipe ECO G GF3.



ECONAVI and INTERNET CONTROL: Optional.

Rating Conditions: Cooling Indoor 27°C DB / 19°C WB. Cooling Outdoor 35°C DB / 24°C WB. Heating Indoor 20°C DB. Heating Outdoor 7°C DB / 6°C WB. (DB: Dry Bulb; WB: Wet Bulb) Specifications subject to change without notice. For detailed information about ErP, please visit our websites [www.aircon.panasonic.eu](http://www.aircon.panasonic.eu) or [www.ptc.panasonic.eu](http://www.ptc.panasonic.eu).



### 100% Fresh air duct function

The New E2 duct with 100% fresh air duct function have exceptional discharge temperature.

	Discharge Range		
	Min	Max	Default
Cooling	15°C	24°C	18°C
Heating	17°C	45°C	40°C

### Plenums

#### Air Outlet Plenum (suitable for rigid + flexible duct)

	Number of exits with diameters	Model
S-224ME1E5A / S-280ME1E5	1 x 500mm	CZ-TREMIESPW706

### Kit for 100% Fresh air function

For 2-Pipe systems		For 3-Pipe systems	
2x CZ-P160RVK2	Rap valve kit	2x CZ-P160HR3	3-Pipe valve kit
2x CZ-CAPE2	3-Pipe control PCB	2x CZ-CAPE2	3-Pipe control PCB
CZ-P680BK2	Distribution Joint kit	CZ-P680BH2	Distribution Joint kit
1x Remote control		1x Remote control	

# HEAT RECOVERY WITH DX COIL



Motorised heat recovery by-pass device automatically controlled by unit control to use fresh air free-cooling when convenient.

- Galvanized steel self-supporting panels, internally and externally insulated
- Counterflow air-to-air heat recovery device, made of sheets of special paper with special sealing to keep airflows separate and only permeable to water vapour. Total heat exchange with temperature efficiency up to 70% and enthalpy efficiency up to 67%, also at high level during summer season
- G4 efficiency class filters with synthetic cleanable media, both on fresh air and return air intake
- Removable side panel to access filters and heat recovery in the event of scheduled maintenance
- Low consumption, high efficiency & low noise direct driven fans
- Supply section complete with DX Coil (R410A) fitted with solenoid control valve, freon filter, contact temperature sensors on liquid and gas line, NTC sensors upstream and downstream airflow
- Built-in electric box equipped with PCB to control internal fan speed and to interconnect outdoor/indoor units
- Duct connection by circular plastic collars
- CZ-RTC5B Timer remote controller (option)

## Balanced Ventilation

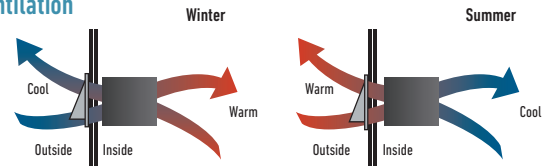

## Interconnection to outdoor/indoor units

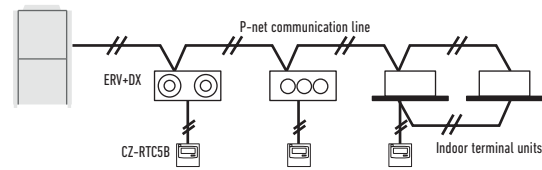

## Characteristic curves

The following curves show the unit external static pressure at maximum fan speed for each model.

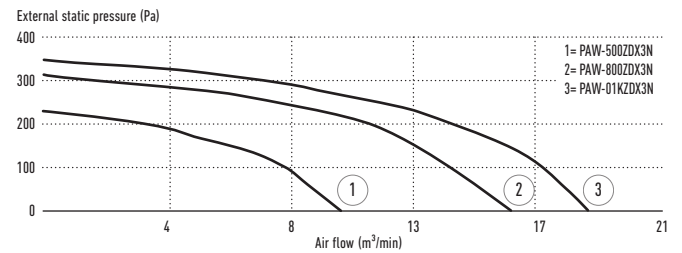

Model	PAW-500ZDX3N		PAW-800ZDX3N		PAW-01KZDX3N		
Power source	Voltage	V	230	230	230	230	
	Phase		Single Phase	Single Phase	Single Phase	Single Phase	
	Frequency	Hz	50	50	50	50	
Air volume		m <sup>3</sup> /min	8,33	13,33	16,66	16,66	
External static pressure <sup>1</sup>		Pa	90	120	115	115	
Maximum current	Total full load	A	0,6	1,4	2,1	2,1	
Input power		W	150	320	390	390	
Sound pressure <sup>2</sup>		dB(A)	39	42	43	43	
Piping connections	Liquid pipe	Inch (mm)	1/4 (6,35)	1/4 (6,35)	1/4 (6,35)	1/4 (6,35)	
	Gas pipe	Inch (mm)	1/2 (12,70)	1/2 (12,70)	1/2 (12,70)	1/2 (12,70)	
<b>Heat recovery</b>			<b>Cooling</b>	<b>Heating</b>	<b>Cooling</b>	<b>Heating</b>	
Temperature efficiency	%		76	76	76	76	
Enthalpy efficiency	%		63	67	63	62	
Saved power summer mode or winter mode*	kW		1,70	4,30 (4,80)	2,50	6,50 (7,30)	3,20
<b>DX Coil</b>			<b>Cooling</b>	<b>Heating</b>	<b>Cooling</b>	<b>Heating</b>	
Total / Sensible capacity	kW		3,00 / 2,10	2,50 / 2,70	5,10 / 3,50	4,40 / 4,80	5,80 / 4,10
Off temperature	°C		15,9	30,1 (29,2)	17,9	27,5 (26,5)	18,6
Off relative humidity	%		90	16 (15)	90	14 (13)	89

Nominal summer conditions: Outside air: 32°C DB, RH 50%. Ambient air: 26°C DB, RH 50%. Nominal winter conditions: Outside air: -5°C DB, RH 80%. Ambient air: 20°C DB, RH 50%. Cooling mode air inlet condition: 28,5°C DB, RH 50%; evaporating temperature 7°C. Heating mode air inlet condition: 13°C DB, RH 40% (11°C DB, RH 45%); condensating temperature 40°C. DB: Dry Bulb; RH: Relative Humidity.

1) Referred to the nominal air flow after filter and plate heat exchanger. 2) Sound pressure level calculated at 1m far from: ducted supply exhaust air ducted return - first air intake / service side, at normal condition. \* Tentative data.



ECONAVI and INTERNET CONTROL: Optional.



ECOi and ECO G Systems Indoor units

## T2 TYPE CEILING

The T2 TYPE ceiling mounted units feature a DC-Fan motor for increased efficiency and reduced operating sound levels. All the units are the same height and depth for a uniform appearance in mixed installations and feature a fresh air knockout for improved air quality.

### Technical focus

- Low sound levels
- New design, all units just 235mm high
- Large and wide air distribution
- Easy to install and maintain
- Fresh air knockout

### Further comfort improvement

The wide air discharge opening widens the airflow to the left and the right, so that a comfortable temperature is obtained in the entire room. The unpleasant feeling caused when the airflow directly hits the human body is prevented by the "Draft prevention position", which changes the swing width, so that the degree of comfort is increased.

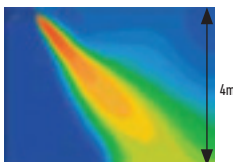

### Further comfort improvement with airflow distribution

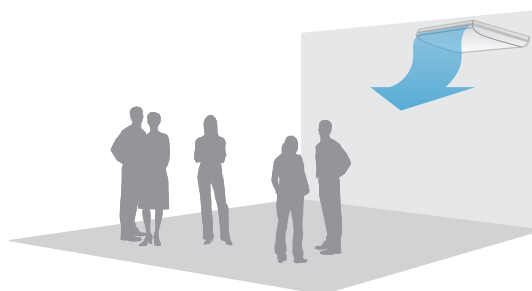

### Air distribution is automatically altered depending on the operational mode

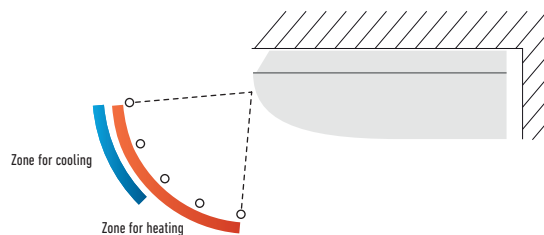

Optional Controller. Control for hotel application PAW-RE2C3



Optional Controller. Wired remote controller C2-RTCSB Compatible with Econavi and datanavi



Optional Econavi Sensor. C2-CENS1



Optional Controller. Wireless remote controller C2-RWST3N



Optional Controller. Simplified remote controller C2-RE2C2

Model		S-36MT2E5A	S-45MT2E5A	S-56MT2E5A	S-73MT2E5A	S-106MT2E5A	S-140MT2E5A
Cooling capacity	kW	3,60	4,50	5,60	7,30	10,60	14,00
Input power cooling	W	35,00	40,00	40,00	55,00	80,00	100,00
Operating current cooling	A	0,36	0,38	0,38	0,44	0,67	0,79
Heating capacity	kW	4,20	5,00	6,30	8,00	11,40	16,00
Input power heating	W	35,00	40,00	40,00	55,00	80,00	100,00
Operating current heating	A	0,36	0,38	0,38	0,44	0,67	0,79
Fan type		Sirocco fan	Sirocco fan	Sirocco fan	Sirocco fan	Sirocco fan	Sirocco fan
Air volume	Hi / Med / Lo m <sup>3</sup> /min	14,00 / 12,00 / 10,50	15,00 / 12,50 / 10,50	15,00 / 12,50 / 10,50	21,00 / 18,00 / 15,50	30,00 / 25,00 / 23,00	32,00 / 28,00 / 24,00
Sound pressure	Hi / Med / Lo dB(A)	36 / 32 / 30	37 / 33 / 30	37 / 33 / 30	39 / 35 / 33	42 / 37 / 36	46 / 40 / 37
Sound power	Hi / Med / Lo dB	54 / 50 / 48	55 / 51 / 48	55 / 51 / 48	57 / 53 / 51	60 / 55 / 54	62 / 58 / 55
Dimension	H x W x D mm	235 x 960 x 690	235 x 960 x 690	235 x 960 x 690	235 x 1275 x 690	235 x 1590 x 690	235 x 1590 x 690
Net weight	kg	27	27	27	33	40	40
Piping connections	Liquid pipe Inch (mm)	1/4 (6,35)	1/4 (6,35)	1/4 (6,35)	3/8 (9,52)	3/8 (9,52)	3/8 (9,52)
	Gas pipe Inch (mm)	1/2 (12,70)	1/2 (12,70)	1/2 (12,70)	5/8 (15,88)	5/8 (15,88)	5/8 (15,88)

\* Tentative data.



ECONAVI and INTERNET CONTROL: Optional.

## K2 TYPE WALL MOUNTED

The Wall mounted unit has a stylish smooth panel that looks good and easy to clean. The unit is also smaller, lighter and substantially quieter than previous models making it ideal for small offices and other commercial applications.

### Technical focus

- Closed discharge port
- Lighter and smaller units make the installation easy
- Quiet operation
- Smooth and durable design
- Piping outlet in three directions
- Air distribution is automatically altered depending on the operational mode

### Closed discharge port

When the unit is turned OFF, the flap closes completely to prevent entry of dust into the unit and to keep the equipment clean. Lighter and smaller units make the installation easy. The width has been decreased by 17% and the units are lighter.

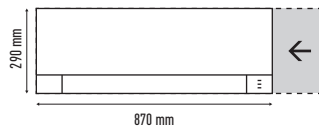

Air distribution is automatically altered depending on the operational mode of the unit

### Quiet operation

These units are among the quietest in the industry, making them ideal for hotels and hospitals.

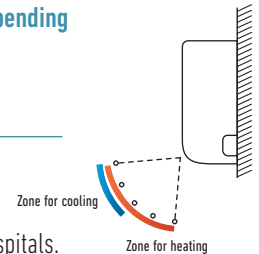

### Smooth and durable design

The smooth cover means these units match most modern interiors. Their compact size enables them to blend in, even in small spaces.

### Piping outlet in six directions

Piping outlet is possible in the six directions of right, right rear, right bottom, left, left rear and left bottom, making the installation work easier.

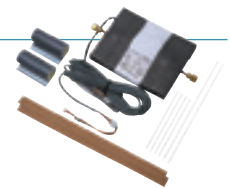

### External valve (Optional)

- CZ-P56SVK2 (model sizes 15 to 56)
- CZ-P160SVK2 (model sizes 73 to 106)



Model		S-15MK2E5A	S-22MK2E5A	S-28MK2E5A	S-36MK2E5A	S-45MK2E5A	S-56MK2E5A	S-73MK2E5A	S-106MK2E5A	
Cooling capacity	kW	1,50	2,20	2,80	3,60	4,50	5,60	7,30	10,60	
Input power cooling	W	25,00	25,00	25,00	30,00	30,00	35,00	55,00	80,00	
Operating current cooling	A	0,20	0,21	0,23	0,25	0,32	0,35	0,51	0,70	
Heating capacity	kW	1,70	2,50	3,20	4,20	5,00	6,30	8,00	11,40	
Input power heating	W	25,00	25,00	25,00	30,00	30,00	35,00	55,00	80,00	
Operating current heating	A	0,20	0,21	0,23	0,25	0,32	0,35	0,51	0,70	
Fan type		Cross flow	Cross flow	Cross flow	Cross flow	Cross flow	Cross flow	Cross flow	Cross flow	
Air volume	Cool	m <sup>3</sup> /min	7,90 / 7,40 / 6,50	9,00 / 7,50 / 6,50	9,50 / 8,30 / 6,50	10,90 / 9,00 / 6,50	14,50 / 12,50 / 10,00	16,00 / 14,00 / 12,00	19,50 / 17,00 / 14,00	21,50 / 18,50 / 15,00
	Heat	m <sup>3</sup> /min	9,00 / 7,70 / 6,80	9,20 / 8,30 / 6,80	9,70 / 8,50 / 6,80	11,20 / 9,50 / 6,80	14,50 / 12,50 / 10,00	16,00 / 14,00 / 12,00	19,50 / 17,00 / 14,00	21,50 / 18,50 / 15,00
Sound pressure	Hi / Med / Lo	dB(A)	34 / 32 / 29	36 / 33 / 29	37 / 34 / 29	40 / 36 / 29	38 / 35 / 33	40 / 37 / 35	47 / 44 / 40	49 / 46 / 42
Sound power	Hi / Med / Lo	dB	49 / 47 / 44	51 / 48 / 44	52 / 49 / 44	55 / 51 / 44	53 / 50 / 48	55 / 52 / 50	62 / 59 / 55	64 / 61 / 57
Dimension	H x W x D	mm	290 x 870 x 214	290 x 870 x 214	290 x 870 x 214	290 x 870 x 214	302 x 1120 x 236	302 x 1120 x 236	302 x 1120 x 236	302 x 1120 x 236
Net weight		kg	9	9	9	9	13	13	14	14
Piping connections	Liquid pipe	Inch (mm)	1/4 (6,35)	1/4 (6,35)	1/4 (6,35)	1/4 (6,35)	1/4 (6,35)	1/4 (6,35)	3/8 (9,52)	3/8 (9,52)
	Gas pipe	Inch (mm)	1/2 (12,70)	1/2 (12,70)	1/2 (12,70)	1/2 (12,70)	1/2 (12,70)	1/2 (12,70)	5/8 (15,88)	5/8 (15,88)



ECONAVI and INTERNET CONTROL: Optional.

ECOi and ECO G Systems Indoor units

# P1 TYPE FLOOR STANDING

P1 Type. The compact floor standing P1 units are the ideal solution for providing perimeter air conditioning. The standard wired controller can be incorporated into the body of the unit.

### Technical focus

- Pipes can be connected to either side of the unit from the bottom or rear
- Easy to install
- Front panel opens fully for easy maintenance
- Removable air discharge grille gives flexible airflow
- Room for condensate pump
- For build-in remote control, only CZ-RTC2 is suitable



### Effective perimeter handling

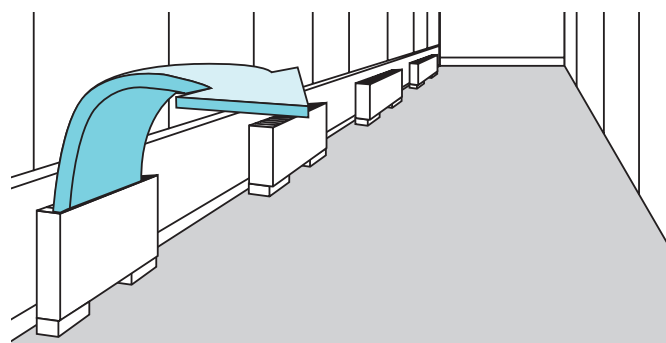

### Effective perimeter handling

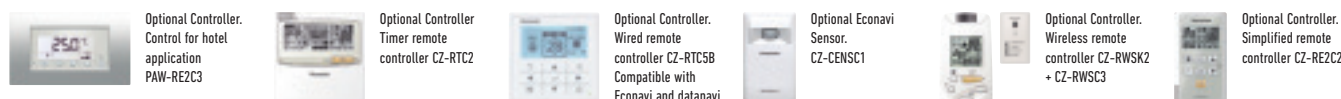

Model		S-22MP1E5	S-28MP1E5	S-36MP1E5	S-45MP1E5	S-56MP1E5	S-71MP1E5
Cooling capacity	kW	2,20	2,80	3,60	4,50	5,60	7,10
Input power cooling	W	56,00	56,00	85,00	126,00	126,00	160,00
Operating current cooling	A	0,25	0,25	0,38	0,56	0,56	0,72
Heating capacity	kW	2,50	3,20	4,20	5,00	6,30	8,00
Input power heating	W	40,00	40,00	70,00	91,00	91,00	120,00
Operating current heating	A	0,18	0,18	0,31	0,41	0,41	0,54
Fan type		Sirocco fan	Sirocco fan	Sirocco fan	Sirocco fan	Sirocco fan	Sirocco fan
Air volume	Hi / Med / Lo m <sup>3</sup> /min	7,00 / 6,00 / 5,00	7,00 / 6,00 / 5,00	9,00 / 7,00 / 6,00	12,00 / 9,00 / 8,00	15,00 / 13,00 / 11,00	17,00 / 14,00 / 12,00
Sound pressure	Hi / Med / Lo dB(A)	33 / 30 / 28	33 / 30 / 28	39 / 35 / 29	38 / 35 / 31	39 / 36 / 31	41 / 38 / 35
Dimension	HxWxD mm	615x1065x230	615x1065x230	615x1065x230	615x1380x230	615x1380x230	615x1380x230
Net weight	kg	29	29	29	39	39	39
Piping connections	Liquid pipe Inch (mm)	1/4 (6,35)	1/4 (6,35)	1/4 (6,35)	1/4 (6,35)	1/4 (6,35)	3/8 (9,52)
	Gas pipe Inch (mm)	1/2 (12,70)	1/2 (12,70)	1/2 (12,70)	1/2 (12,70)	1/2 (12,70)	5/8 (15,88)



ECONAVI and INTERNET CONTROL: Optional.

# R1 TYPE CONCEALED FLOOR STANDING



R1 Type. At just 229mm deep, the R1 unit can be easily concealed in perimeter areas to provide powerful and effective air conditioning.

### Technical focus

- Chassis unit for discreet installation
- Complete with removable filters
- Pipes can be connected to either side of the unit from the bottom or rear
- Easy to install

### Perimeter air conditioning with high interior quality

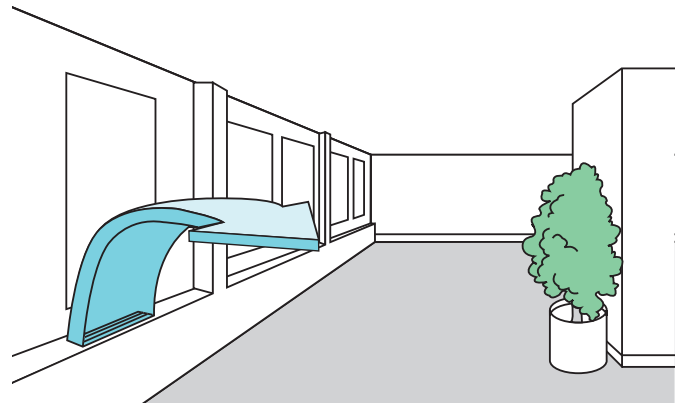

Optional Controller. Control for hotel application PAW-RE2C3



Optional Controller Timer remote controller CZ-RTC2



Optional Controller. Wired remote controller CZ-RTC5B Compatible with Econavi and datanavi



Optional Econavi Sensor. CZ-CENSC1



Optional Controller. Wireless remote controller CZ-RWSK2 + CZ-RWSC3



Optional Controller. Simplified remote controller CZ-RE2C2

Model		S-22MR1E5	S-28MR1E5	S-36MR1E5	S-45MR1E5	S-56MR1E5	S-71MR1E5
Cooling capacity	kW	2,20	2,80	3,60	4,50	5,60	7,10
Input power cooling	W	56,00	56,00	85,00	126,00	126,00	160,00
Operating current cooling	A	0,25	0,25	0,38	0,56	0,56	0,72
Heating capacity	kW	2,50	3,20	4,20	5,00	6,30	8,00
Input power heating	W	40,00	40,00	70,00	91,00	91,00	120,00
Operating current heating	A	0,18	0,18	0,31	0,41	0,41	0,54
Fan type		Sirocco fan	Sirocco fan	Sirocco fan	Sirocco fan	Sirocco fan	Sirocco fan
Air volume	Hi / Med / Lo m <sup>3</sup> /min	7,00 / 6,00 / 5,00	7,00 / 6,00 / 5,00	9,00 / 7,00 / 6,00	12,00 / 9,00 / 8,00	15,00 / 13,00 / 11,00	17,00 / 14,00 / 12,00
Sound pressure	Hi / Med / Lo dB(A)	33 / 30 / 28	33 / 30 / 28	39 / 35 / 29	38 / 35 / 31	39 / 36 / 31	41 / 38 / 35
Dimension	HxWxD mm	616 x 904 x 229	616 x 904 x 229	616 x 904 x 229	616 x 1219 x 229	616 x 1219 x 229	616 x 1219 x 229
Net weight	kg	21	21	21	28	28	28
Piping connections	Liquid pipe Inch (mm)	1/4 (6,35)	1/4 (6,35)	1/4 (6,35)	1/4 (6,35)	1/4 (6,35)	3/8 (9,52)
	Gas pipe Inch (mm)	1/2 (12,70)	1/2 (12,70)	1/2 (12,70)	1/2 (12,70)	1/2 (12,70)	5/8 (15,88)



ECONAVI and INTERNET CONTROL: Optional.

ECOi Systems Indoor units

# HYDROKIT FOR ECOi WATER AT 45°C



Connect the Hydrokit to your VRF system, together with other indoor units.

### Basic principle & advantage

Hydrokit module provides hot water by using waste heat that is recovered from standard air-conditioning indoor unit in cooling mode. Total system performs high energy efficiency by this heat recovering operation, and it gives an advantage for sustainability related assessment methods, such as BREEAM in UK.

### Hydrokit control function / CZ-RTC5B

- CZ-RTC5B is updated version from CZ-RTC3. It can be used for hydrokit and also normal indoor unit. CZ-RTC5B checks the type of connected unit and switch hydrokit or air conditioner style of display automatically
- Operating mode on hydrokit style to be set at initial setting of the system from following modes: tank mode or air conditioning mode

### Technical focus

- Only with 3-Pipe ECOi MF2 6N Series outdoor units
- Remote controller CZ-RTC5B common use with DX Coil indoor units ECOi and PACi

### Overview: hydromodule in VRF system

- Multiple hydromodule connection in same circuit is available
- Each module can be set different operation mode either hot water supply mode or space heating mode (both operation modes are not able to set at 1 hydromodule)
- 3-Pipe control solenoid valve kit is necessary for each indoor unit and hydromodule

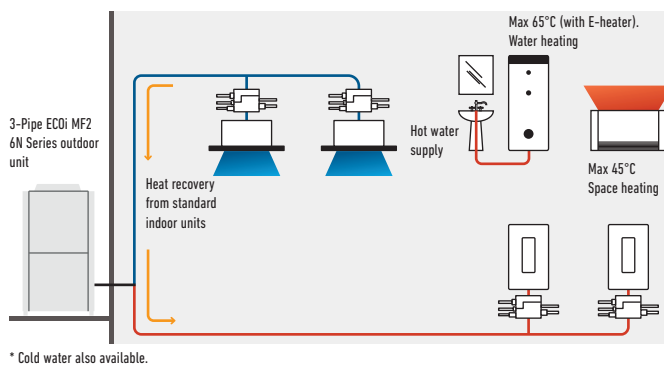

Optional Controller. Control for hotel application PAW-RE2C3



Optional Controller. Wired remote controller CZ-RTC5B Compatible with Econavi and datanavi



Optional Econavi Sensor. CZ-CENS1

Model*	S-80MW1E5			S-125MW1E5		
Power source	230V / Single Phase / 50 Hz			230V / Single Phase / 50 Hz		
Cooling capacity	kW	8,00		12,50		
Heating capacity	kW	9,00		14,00		
Maximum temperature	°C	~45 / ~65 <sup>1</sup>		~45 / ~65 <sup>1</sup>		
Dimension	HxWxD	mm 892 x 502 x 353		mm 892 x 502 x 353		
Water pipe connector	Inch	R 1 ¼		R 1 ¼		
Water pump (built-in)		DC motor (A class)		DC motor (A class)		
Water flow rate	Cool	L/min	22,90	35,80		
	Heat	L/min	25,80	40,10		
Piping connections	Liquid pipe	Inch (mm)	3/8 (9,52)	3/8 (9,52)		
	Gas pipe	Inch (mm)	5/8 (15,88)	5/8 (15,88)		
	Drain piping		15 ~ 17mm (inner size)	15 ~ 17mm (inner size)		
Operation range	Cooling	Ambient / Water	°C +10 ~ +43 / +5 ~ +20	°C +10 ~ +43 / +5 ~ +20		
	Heating	Ambient / Water	°C -20 ~ +32 / +25 ~ +45	°C -20 ~ +32 / +25 ~ +45		
Connectable system	3-Pipe (heat recovery type) VRF system (system capable up to 48HP)					
Maximum Indoor ratio (connectable hydrokit module capacity ratio)	Total indoor unit + Hydrokit capacity: up to 130% (** ~ **% vs total outdoor unit capacity)					

1) Max 45°C by refrigerant circuit (heat pump cycle), over 45°C is provided by electric heater operation. \* Tentative Data.



ECONAVI: Optional.

# AQUAREA AIR RADIATORS. FAN COILS FOR HEAT PUMP APPLICATION

AQUAREA  
AIR



## New line up of Super low temperature radiators for Heat Pump application: Aquarea Air 200/700/900 with radiating effect

The slimline Panasonic Aquarea Air radiators deliver high efficiency climate control.

With a depth of just under 13cm they are at the cutting edge of the market. Blending easily into the home, Aquarea Air's elegant design and product refinements are clear to see in every detail. Exceptional ventilation efficiency means the motor uses considerably less energy (low wattage). The fan speed is continuously modulated by the temperature controller with proportional integral logic, with undoubted advantages for regulating the temperature and humidity in summer mode.



With standard cast radiators.

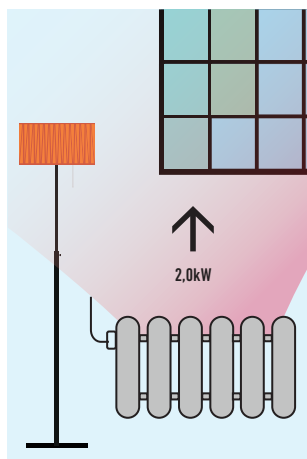

Water at 65°C needed.

With Aquarea Air.

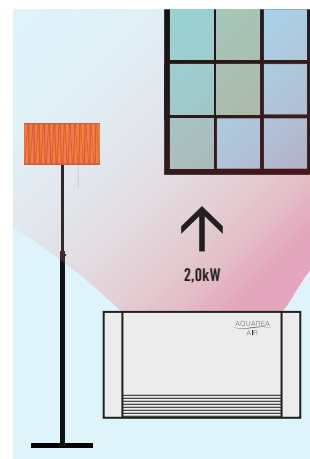

Water at 35°C needed.

### Technical focus:

- Front panel heating with radiant effect
- High heating capacity (without main fan running)
- 4 fan speeds and capacities
- Exclusive design
- Extremely compact (only 12,9cm deep)
- Cooling and dehumidification functions possible (drain is needed)
- 3-way valve included (no overflow valve needed on the installation if more than 3 radiators installed)
- Touch screen thermostat

All temperature curves and capacity are available on [www.panasonicproclub.com](http://www.panasonicproclub.com)

Fan Coils for Heat Pump application		PAW-AAIR-200-1					PAW-AAIR-700-1					PAW-AAIR-900-1				
		W	kg/h	kPa	m <sup>3</sup> /min	Speed	W	kg/h	kPa	m <sup>3</sup> /min	Speed	W	kg/h	kPa	m <sup>3</sup> /min	Speed
Total heating capacity	W	138,00	160,00	217,00	470,00	570,00	223,00	360,00	708,00	1032,00	1188,00	273,00	475,00	886,00	1420,00	1703,00
Water flow	kg/h	23,70	27,50	37,30	80,80	98,00	38,40	61,90	121,80	177,50	204,30	47,00	81,70	152,40	244,20	292,90
Water pressure drop	kPa	0,10	0,20	0,40	2,00	2,90	0,10	0,10	0,30	0,80	1,00	0,10	0,20	0,50	1,60	2,20
	m <sup>3</sup> /min	0,50	0,60	0,90	1,90	2,70	0,70	1,40	2,60	4,20	5,30	0,90	1,80	4,10	6,10	7,70
Air flow	Speed	Main Fan Off	Super Min	Min	Med	Max	Main Fan Off	Super Min	Min	Med	Max	Main Fan Off	Super Min	Min	Med	Max
Maximum input power	W	2,00	5,00	7,00	9,00	13,00	3,00	9,00	14,00	18,00	22,00	3,00	11,00	16,00	20,00	24,00
Sound pressure	dB(A)	17,60	18,80	24,70	33,20	39,40	18,40	19,60	25,80	34,10	40,20	18,40	22,30	26,20	34,40	42,20
Inlet water temperature	°C	35	35	35	35	35	35	35	35	35	35	35	35	35	35	35
Outlet water temperature	°C	30	30	30	30	30	30	30	30	30	30	30	30	30	30	30
Inlet air temperature	°C	19	19	19	19	19	19	19	19	19	19	19	19	19	19	19
Outlet air temperature	°C	34,50	32,60	38,90	32,00	30,00	34,90	32,40	33,30	31,80	30,60	34,80	32,50	30,20	31,10	30,60
Dimension (HxWxD)	mm	579 x 735 x 129					579 x 935 x 129					579 x 1135 x 129				
Net weight	kg	17					20					23				
3 ways valve included		Yes					Yes					Yes				
Touch screen thermostat		Yes					Yes					Yes				

## NEW VERSATILE AND EFFICIENT FAN COIL RANGE. FAN COIL COMPATIBLE WITH AQUAREA AND VRF SYSTEMS

NEW  
18

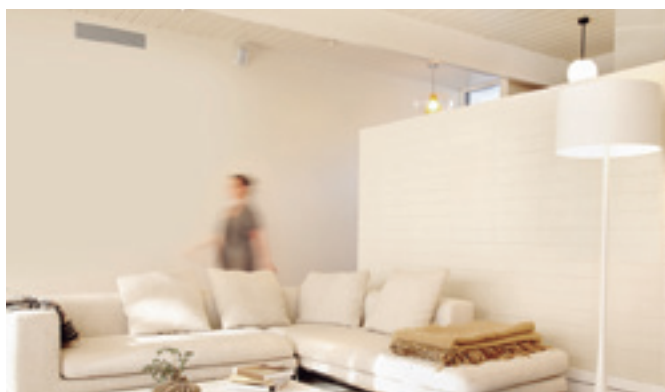
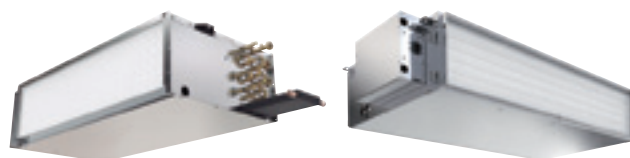

### New range of Fan Coil units

Easy to install, improvement in sounds levels and performances, are the key developments carried on our Fan Coil units. The Fan Coil is issued from that development striving to meet customers' wishes and advices.

New Fan Coil range consist on one compact ducted range ideal for residential and commercial use and one model with high static pressure for commercial applications. The range certified by Eurovent includes drain pan and filter and are equipped with a low consumption fan motor. Easy maintenance and access.

### 1 Innovation for an optimum comfort

New range of Fan Coil for heating and cooling with 6 capacities from 2,4 to 14,8kw in cooling and from 3,0 to 19,9kW in heating. It can bring full year comfort together with an Aquarea system or VRF systems.

### 2 Low energy consumption fan

5 Speed level. The units are fitted with a fan-motor assembly of which the fan is composed of double inlet forward curved centrifugal wheel dynamically balanced and specially designed for an optimal air flow.

### 3 Quality and efficient Coil

Made of staggered copper tubes, mechanically expanded into aluminium fins, assuring maximum heat transfer efficiency. Equipped with a main chilled water coil with 3 rows.

### 4 Easy and flexible installation

- Suction G2 air filter from both sides and for the bottom
- Includes drain pan

Model	Compact units						High Static Pressure	
		PAW-FC-D24	PAW-FC-D40	PAW-FC-D55	PAW-FC-D65	PAW-FC-D90	PAW-FC-H150	
Total cooling capacity	Med / S-Hi	kW	2,00 / 2,40	3,10 / 4,10	4,20 / 5,50	5,80 / 6,60	6,70 / 9,10	11,90 / 14,80
Sensible cooling	Med / S-Hi	kW	1,70 / 2,10	2,20 / 3,00	3,00 / 4,00	4,30 / 5,00	4,90 / 7,00	9,60 / 12,90
Heating capacity	Med / S-Hi	kW	2,40 / 3,00	3,90 / 5,40	4,00 / 5,30	7,40 / 8,70	9,30 / 12,60	14,90 / 19,90
Power consumption	S-Lo / Med / S-Hi	W	24 / 50 / 81	33 / 57 / 86	39 / 76 / 112	60 / 114 / 161	90 / 112 / 188	180 / 421 / 675
Fuse rating		A	2,00	2,00	2,00	2,00	2,00	3,17
Dimensions	H x W x D	mm	220 x 624 x 430	220 x 994 x 430	220 x 1179 x 430	220 x 994 x 530	220 x 1250 x 530	356 x 1380 x 798
Dimensions (including pan and electrical box)	H x W x D	mm	220 x 862 x 430	220 x 1232 x 430	220 x 1417 x 430	220 x 1232 x 530	220 x 1463 x 530	356 x 1600 x 798
Weight (without water content)		kg	15,5	24	28	29	43	63
Sound power global	S-Lo / Med / S-Hi	dB(A)	31 / 45 / 53	36 / 48 / 57	40 / 52 / 58	46 / 59 / 63	52 / 57 / 66	52 / 64 / 71
Static pressure	Max	Pa	50	70	70	70	70	110
Airflow <sup>1)</sup>	Med / S-Hi	m <sup>3</sup> /h	388 / 483	486 / 716	640 / 933	989 / 1064	936 / 1397	2112 / 3176
Water pressure drop	Med / S-Hi	kPa	9,9 / 14,3	13,0 / 22,4	25,2 / 42,2	13,9 / 17,9	22,6 / 40,3	19,8 / 26,1
Fan speeds			3 speeds	3 speeds	3 speeds	3 speeds	3 speeds	3 speeds
Fan motor and total speeds			AC 5 speeds	AC 5 speeds	AC 5 speeds	AC 5 speeds	AC 5 speeds	AC 5 speeds
Drain pan			Included	Included	Included	Included	Included	Included
Air filter			Included	Included	Included	Included	Included	Included
Water connections		Inch	1/2	1/2	1/2	1/2 (1/4 cooling)	1/2	1

1) Airflow at 0Pa of static pressure.

Performances based on: Summer air 27°C / 19°C (wet Bulb and chilled water 7/12°C - Winter air 20°C, entering water temperature 50°C.

# PANASONIC VENTILATION SOLUTIONS





For maximum savings and easy integration.

### AHU connection kit 16kW, 28kW and 56kW

AHU connection kit contains: IP65 box with PCBs and terminal connections mounted inside, expansion valve and sensors.

Heat exchanger, fan & fan motor to be mounted in the AHU itself shall be provided in the field.

Application: Hotels, offices, server rooms or all large buildings where air quality control such as humidity control and fresh air and is needed.



### AHU Kit combine air conditioning and fresh air in just one solution.

New AHU Kits connect ECOi systems to air handling unit systems, using the same refrigerant circuit as the VRF system.

Large connectivity possibilities mean the Panasonic AHU Kit can be easily integrated.

### 3 types of AHU Kit: Deluxe, Medium and Light.

Model Code	IP 65	0-10V demand control*	Outdoor temperature shift compensation. Cold draft prevention
PAW-160MAH2 / PAW-280MAH2 / PAW-560MAH2	Yes	Yes	Yes
PAW-160MAH2M / PAW-280MAH2M / PAW-560MAH2M	Yes	Yes	No
PAW-160MAH2L / PAW-280MAH2L / PAW-560MAH2L	Yes	No	No

\* With C2-CAPBC2.

### Heat Recovery With DX Coil

Motorised heat recovery by-pass device automatically controlled by unit control to use fresh air free-cooling when convenient.



- Galvanized steel self-supporting panels, internally and externally insulated
- Counterflow air-to-air heat recovery device, made of sheets of special paper with special sealing to keep airflows separate and only permeable to water vapour. Total heat exchange with temperature efficiency up to 77% and enthalpy efficiency up to 63%, also at high level during summer season
- G4 efficiency class filters with synthetic cleanable media, both on fresh air and return air intake
- Removable side panel to access filters and heat recovery in the event of scheduled maintenance
- Low consumption, high efficiency & low noise direct driven fans with 3-speed EC motors
- Supply section complete with DX Coil (R410A) fitted with solenoid control valve, freon filter, contact temperature sensors on liquid and gas line, NTC sensors upstream and downstream airflow

### Air Curtain with DX Coil

#### Highly efficient heating effect.

The combined air stream, which has a desirable low air current induction factor (mixing factor), can carry the selected initial temperature effect over long distances, and will reach the floor area while still at room temperature. This is necessary to avoid cooling down the interior spaces.



The Panasonic range of air curtains is designed for smooth operation and efficient performance. Air curtains produce a continuous stream of air blown from the top to the bottom of an open doorway and create a barrier that people and products can flow across, but air can't. Designed to improve energy efficiency, minimise heat loss from a building, and to allow retailers to keep doors open to encourage customers, our Air Curtains are suitable for connection to both VRF and PACi Systems.

Heating capacity comparison: Electrical air curtain / Panasonic air curtain

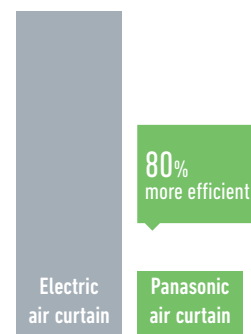

\* With the U-100PE1E5A on the PAW-20PAIRC-MS. Calculation method: Taking as consideration SCOP of the Panasonic combination of 6.0. If 100 is the energy needed for a air curtain, Panasonic Air curtain will need 1/(1-6)\*100=20.

### Energy Recovery Ventilation

Panasonic Energy Recovery Ventilators help you with your comfort and energy-saving plan.



Panasonic Energy Recovery Ventilators can reduce the outside air load because they efficiently recover the heat lost by ventilation during the heat recovery process. This results in energy-saving ventilation and lower running costs for air-conditioning and heating equipment. Furthermore, by designing our current models with an counter-flow heat-exchange element, we achieved products with slim body shapes and quiet operation that create a comfortable and pleasant air-conditioned environment while saving energy.

- Dramatic energy savings achieved through adoption of a high-efficiency counter-flow heat-exchange element
- Counter-flow heat exchange element used for reduced noise and slimmer, more compact body shape
- All maintenance can be performed through a single inspection hole
- Straight air supply / exhaust system used for easier installation

When a regular ventilation fan is used<sup>1</sup> When a Energy Recovery Ventilator is used<sup>2</sup>

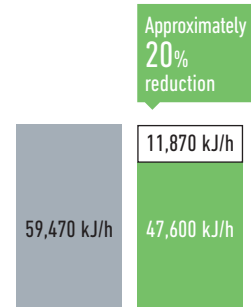

1) Two FY-27FPK7 units. 2) One FY-500ZY6R unit.

# AHU CONNECTION KIT 16, 28 AND 56kW FOR ECOi AND ECO G



## Panasonic AHU Kit, 16-56kW connected to ECOi or ECO G

PCB, Transformer, Solenoid Control Valve, Thermistor x 4 pcs, Terminal Base and Electrical Component Box.

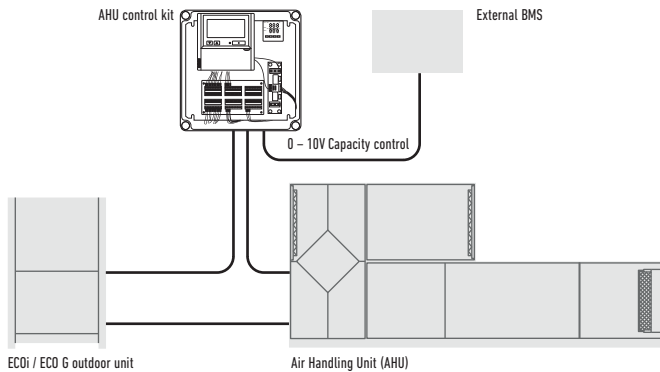

Demand control on the outdoor unit managed by external 0-10 V signal.

**System example for large capacity (more than 56kW)**  
 3 x [PCB, Transformer, Solenoid Control Valve, Thermistor x 4 pcs, Terminal Base and Electrical Component Box].  
 Example 140kW system

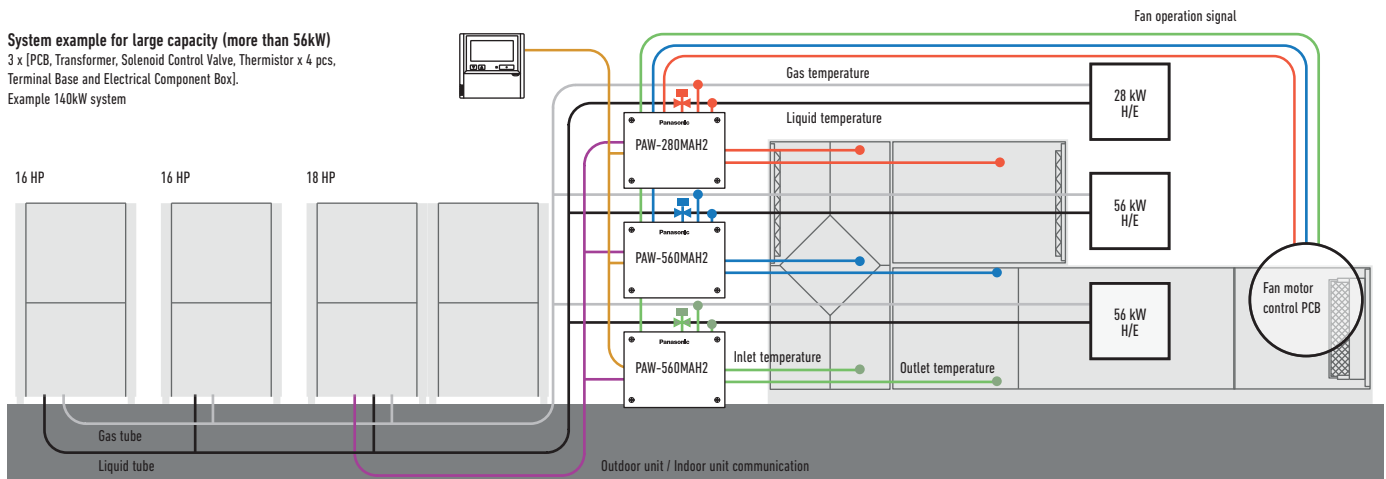

## Optional parts: Following functions are available by using different control accessories:

### CZ-RTC4 Timer remote controller.

- Operation-ON/OFF
- Mode select
- Temperature setting

\* Fan operation signal can be taken from the PCB.

### CZ-T10 terminal.

- Input signal= Operation ON/OFF
- Remote controller prohibition
- Output signal= Operating-ON status
- Alarm output (by DC12V)

### PAW-OCT, DC12 V outlet. OPTION terminal.

- Output signal= Cooling/Heating/Fan status
- Defrost
- Thermostat-ON

### CZ-CAPBC2 Mini seri-para I/O unit.

- Demand control 40% to 120% (5% steps) by 0-10V input signal
- Temperature setting by 0-10V or 0-140 Ω input signal
- Room (inlet air) temp outlet by 4-20mA
- Mode select or/and ON/OFF control
- Fan operation control
- Operation status output/ Alarm output
- Thermostat ON/OFF control

### PAW-T10 PCB to connect to T10 connector.

- A Dry contact PCB has been developed to easily control the unit
- Input signal operation ON/OFF
- Remote control prohibition
- Output signal Operation ON status maximum 230V 5A (NO/NC)
- Output signal alarm status max. 230 V 5 A (NO/NC)
- Additional available contacts:
  - External humidifier control (ON/OFF) 230 VAC 3A
  - External fan control (ON/OFF) 12V DC
  - External filter status signal potential free
  - External float switch signal potential free
  - External leakage detection sensor or TH. OFF contact potential free (possible usage for external blow out temperature control)

ECOi and ECO G Systems Ventilation units

ECOi 2-Pipe 6N Series outdoor unit shall be used for AHU Connection Kit. 3 models for VRF system: 5HP (PAW-160MAH2/M/L), 10HP (PAW-280MAH2/M/L) and 20HP (PAW-560MAH2/M/L).

**With ECO G outdoor units**

- One AHU kit may be used for one ECO G unit (2-Pipe, 56kW). Multiple AHU kits cannot be used
- Mixed with standard indoor units is not allowed
- Power specifications are Single Phase 220V to 240V

**Technical focus**

- Maximum capacity/system: 60HP (168kW)
- Maximum piping length: 100m (120m equivalent)
- Elevation difference (indoor unit / indoor unit): 4m
- In/Out capacity ratio: 50~100%
- Maximum indoor unit number: 3 units\*
- Outdoor temperature range in heating: -20 ~ +15°C
- Available temperature range for the suction air at AHU Kit: cool: +18 ~ +32°C / heat: +16 ~ +30°C

\* To be simultaneous operation controlled by one remote controller sensor.

- The systems is controlled by the suction air (or room return air) temperature (same as standard indoor unit). (Selectable mode: Automatic / Cooling / Heating / Fan / Dry (but same as Cool))
- The discharge air temperature is also controlled to prevent too-low air discharge in cooling or too-high air discharge in heating (in case of VRF)
- Demand control (Forcible thermostat-OFF control by operating current)
- Defrost operation signal, Thermo-ON/OFF states output
- Drain pump control (Drain-pump and the float switch to be supplied in local)
- External target temperature setting via Indoor/Outdoor signal interface is available with CZ-CAPBC2 (Ex. 0 – 10V)
- Demand control 40% to 120% (5% steps) by 0-10V input signal
- Connectable with P-Link system. Special care for electrical noise may be necessary depending on the on-side system
- Fan control signal from the PCB can be used for control the air volume (high/mid/low and LL for Th-OFF). Need to change the fan control circuit wiring at field

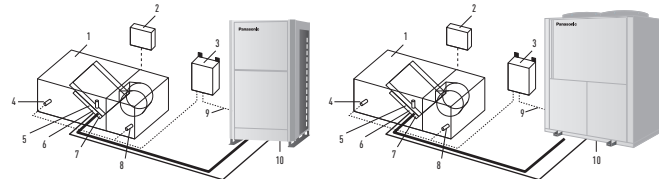

**System & regulations. System overview.**

1. AHU Unit equipment (field supplied)
2. AHU Unit system controller (field supplied)
3. AHU Kit controller box (with control PCB)
4. Thermistor for discharge air
5. Electronic expansion valve
6. Thermistor for gas pipe (E3)
7. Thermistor for liquid pipe (E1)
8. Thermistor for suction air
9. Inter-unit wiring
10. Outdoor unit

HP	5HP		10HP		20HP		30HP		40HP		50HP		60HP	
	PAW-160MAH2/M/L		PAW-280MAH2/M/L		PAW-560MAH2/M/L		PAW-280MAH2/M/L		PAW-560MAH2/M/L		PAW-560MAH2/M/L		PAW-560MAH2/M/L	
Nominal cooling capacity @ 50Hz	kW		14,00		28,0		56,0		84,0		112,0		140,0	
Nominal heating @ 50Hz	kW		16,00		31,5		63,0		95,0		127,0		155,0	
Cooling airflow	Hi / Lo	m <sup>3</sup> /min	2600 / 1140		5000 / 3500		10000 / 7000		15000 / 10500		20000 / 14000		25000 / 17500	
Bypass factor			0,9 (recommended)		0,9 (recommended)		0,9 (recommended)		0,9 (recommended)		0,9 (recommended)		0,9 (recommended)	
Dimensions	H x W x D	mm	303x232x110		404x425x78		404x425x78		404x425x78		404x425x78		404x425x78	
Weight		kg	3,2		6,3		6,3		6,3		6,3		6,3	
Piping length	Min / Max	m	10 / 100		10 / 100		10 / 100		10 / 100		10 / 100		10 / 100	
Elevation difference (in/out)	Max	m	10		10		10		10		10		10	
Piping connections	Liquid pipe	Inch (mm)	3/8 (9,52)		3/8 (9,52)		5/8 (15,88)		3/4 (19,05)		3/4 (19,05)		3/4 (19,05)	
	Gas pipe	Inch (mm)	5/8 (15,88)		7/8 (22,22)		1 1/8 (28,58)		1 1/4 (31,75)		1 1/2 (38,15)		1 1/2 (38,15)	
Intake temperature of AHU Kit	Cool Min~Max	°C	+18~+32(+13~+23)		+18~+32(+13~+23)		+18~+32(+13~+23)		+18~+32(+13~+23)		+18~+32(+13~+23)		+18~+32(+13~+23)	
	Heat Min~Max	°C	+16~+30		+16~+30		+16~+30		+16~+30		+16~+30		+16~+30	
Ambient temperature of outdoor unit	Cool Min~Max	°C	-10~+43		-10~+43		-10~+43		-10~+43		-10~+43		-10~+43	
	Heat Min~Max	°C	-20~+15		-20~+15		-20~+15		-20~+15		-20~+15		-20~+15	

**AHU connection kit / System combination**

Capacity (HP)	Outdoor unit combination			AHU kit combination		
28kW (10HP)	U-10ME2E81			PAW-280MAH2		
56kW (20HP)	U-20ME2E81			PAW-560MAH2		
84kW (30HP)	U-16ME2E81	U-14ME2E81		PAW-560MAH2	PAW-280MAH2	
112kW (40HP)	U-20ME2E81	U-20ME2E81		PAW-560MAH2	PAW-560MAH2	
140kW (50HP)	U-18ME2E81	U-16ME2E81		PAW-560MAH2	PAW-560MAH2	PAW-280MAH2
168kW (60HP)	U-20ME2E81	U-20ME2E81		PAW-560MAH2	PAW-560MAH2	PAW-560MAH2
56kW (20HP)	U-20GE3E5			PAW-560MAH2		

## AIR CURTAIN WITH DX COIL, CONNECTED TO THE VRF OR PACi SYSTEMS

### Highly efficient heating effect

The combined air stream, which has a desirable low air current induction factor (mixing factor), can carry the selected initial temperature effect over long distances, and will reach the floor area while still at room temperature. This is necessary to avoid cooling down the interior spaces. Available in different lengths to suit requirements between 1,0 and 2,5m, both air curtains have outlet grilles that can be adjusted to five different positions. The jet flow model can be installed up to a height of 3,5m with the standard model up to 3,0m. The outlet grilles can be easily adjusted into five positions to suit different installations requirements and the air filter can be accessed without the need for specialist tools.

- High performance with EC fan motor (40% lower running costs compared to a standard AC fan motor)
- Easy Cleaning and Servicing
- Can be connected to either Panasonic VRF or PACi systems
- Built-in drain for cooling operation
- Standard and Jet Flow air curtains can be controlled via Panasonic's range of remote internet controls

The new standard and jet-flow models are ideal for connection to a ECOi or PACi system. With simple "plug and play" installation, both are fitted with an EC fan motor for a smooth operation and efficient performance. This new fan guarantees 40% lower running cost than with a standard AC fan motor. Air curtains run approximately 12 hours per day at shops, and efficient performance contributes to energy savings.

### Internet Control

An app added to your tablet or smartphone or via the Internet allows you to control and manage the system remotely. There is also the option to integrate into existing BMS systems by using other Panasonic interfaces.

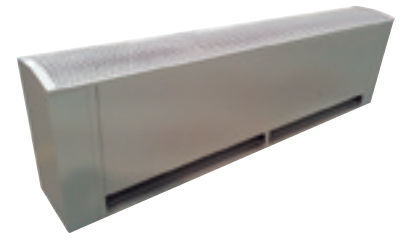
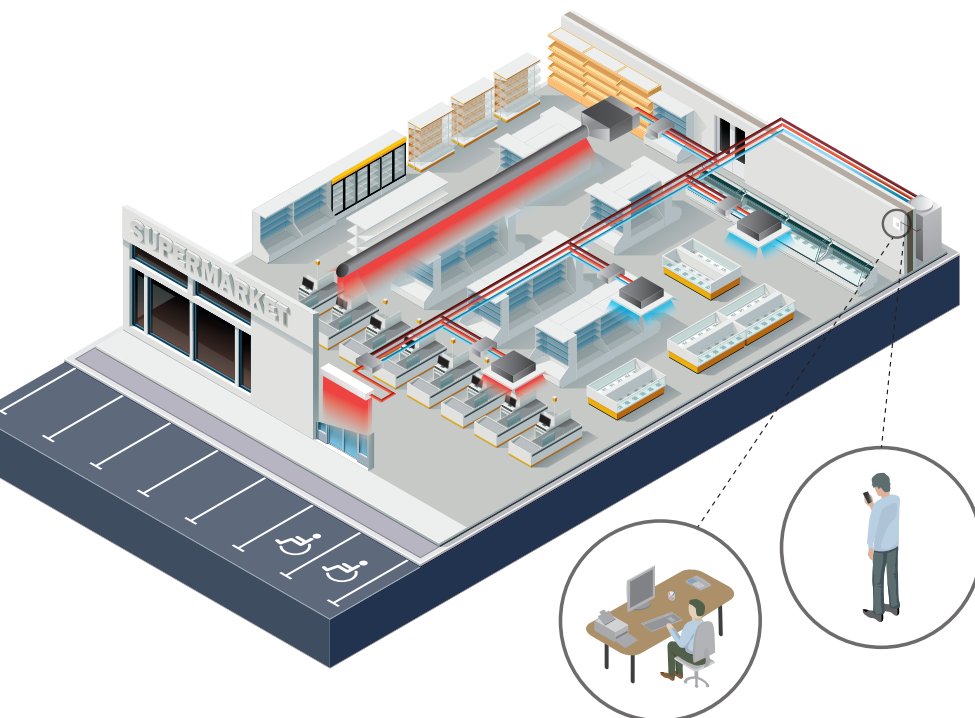

### Intelligent Operation

Our air curtains combine airflow and heating / cooling technology to ensure optimum comfort and energy efficiency whilst also creating an effective barrier between indoor and outdoor environments. Design and installation is key to achieving the correct height / temperature settings to achieve optimum performance. Our air curtains are designed to answer the demands of the retail, commercial and industrial markets.

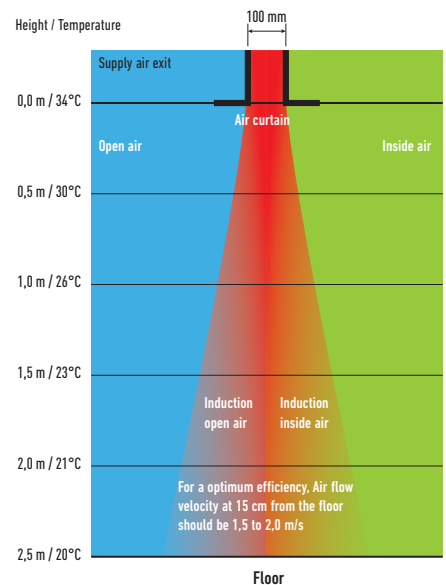

### How does it work?

Stale air from the room is taken in and ejected near the door. This creates a 'roll of air' that shields the door area, mixing with the colder incoming air. It then turns away from the door, back into the room and toward the intake screen, where it is partly drawn in again. This flow of air helps to create a barrier for heat loss yet at the same time refreshes room air

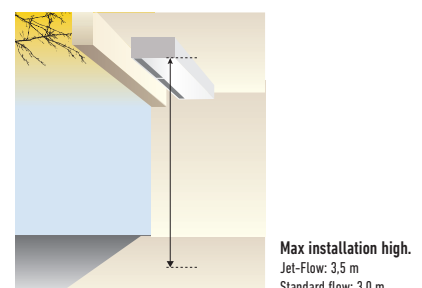

High efficiency air curtain connected to your VRF installation. EC Fan motor for a smooth operation and efficient performance. 2 types of air flow available: Jet-Flow and Standard. Easy cleaning and servicing.



### Technical focus

- Save up to 40% energy costs by use of the integrated EC fan technology (higher efficiency than conventional AC fan, soft start and longer motor duration)
- 3 lengths of air curtains Jet-Flow, from 1,0 to 2,0m and 2 lengths of air curtains Standard, 1,0 and 2,0m
- Installation Height up to 3,5m (Jet-Flow) and 3,0m (Standard)
- Outlet grilles can be adjusted in five positions, to suite different indoor and installation requirements (Jet-Flow)
- Control with Panasonic remote control systems (optional)
- Direct integration to BMS by optional Panasonic interfaces
- Drain included for cooling operation

### Features

#### Comfort.

- Easy redirection of Airflow by means of manual deflector (Jet-Flow)

#### Ease of use.

- Speed selector (high and low) on the unit itself

#### Easy installation and maintenance.

- Easy installation
- Compact dimensions improve installation and positioning (Jet-Flow)
- Easy cleaning of grid without opening of the unit

### Optimised airflow velocity

1. Energy losses, no air curtain installed
2. Too low velocity air curtain – air curtain not efficient
3. Optimum results with the Tekadoor air curtain connected to Panasonic VRF
4. Too high velocity air curtain – considerable turbulence, energy lost to the outside, air curtain not efficient

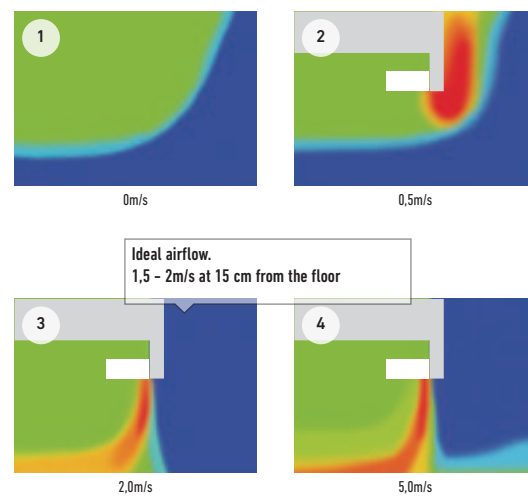

HP			4HP	6HP	8HP	14HP	4HP	8HP
Air Curtain			PAW-10EAIRC-MJ	PAW-15EAIRC-MJ	PAW-20EAIRC-MJ	PAW-25EAIRC-MJ	PAW-10EAIRC-MS	PAW-20EAIRC-MS
Air flow type			Jet-Flow				Standard	
Air Flow Length (A)	m		1,00	1,50	2,00	2,50	1,00	2,00
Air volume	Hi / Med / Lo	m <sup>3</sup> /min	30,00 / 25,00 / 20,00	45,00 / 38,30 / 31,70	60,00 / 50,00 / 41,70	75,00 / 63,30 / 51,70	30,00 / 25,00 / 20,00	45,00 / 38,30 / 31,70
Cooling capacity nominal <sup>2</sup>		kW	9,20	17,50	23,10	24,40	9,20	17,50
Heating capacity nominal		kW	11,40	25,00	31,50	31,50	11,40	31,50
Heating capacity with air in 20°C, air out 40 / 35 / 30°C		kW	11,90 / 8,90 / 5,90	17,90 / 13,40 / 8,90	23,90 / 17,90 / 11,90	29,90 / 22,40 / 14,90	11,90 / 8,90 / 5,900	17,90 / 13,40 / 8,90
Max installation height	Good / Normal / Bad	m	3,5 / 3,1 / 2,7	3,5 / 3,1 / 2,7	3,5 / 3,1 / 2,7	3,5 / 3,1 / 2,7	3 / 2,7 / 2,4	3 / 2,7 / 2,4
Piping connections	Liquid pipe	Inch (mm)	3/8(9,52)	3/8(9,52)	3/8(9,52)	3/8(9,52)	3/8(9,52)	3/8(9,52)
	Gas pipe	Inch (mm)	5/8(15,88)	3/4(19,05)	7/8(22,22)	7/8(22,22)	5/8(15,88)	7/8(22,22)
Noise		dB(A)	40-55	40-56	40-57	40-58	40-55	40-57
Dimension	WxHxD	mm	260 x 1210 x 590	260 x 1710 x 590	260 x 2210 x 590	260 x 2710 x 590	260 x 1210 x 490	260 x 2210 x 490
Net weight		kg	70	100	138	160	60	128
Mini ECOi with air out 40°C			U-4LE1E5/8 <sup>1</sup>	U-6LE1E5/8 <sup>1</sup>	—	—	U-4LE1E5/8 <sup>1</sup>	U-6LE1E5/8 <sup>1</sup>
Mini ECOi with air out 35°C			U-4LE1E5/8 <sup>1</sup>	U-4LE1E5/8 <sup>1</sup>	U-6LE1E5/8 <sup>1</sup>	—	U-4LE1E5/8 <sup>1</sup>	U-4LE1E5/8 <sup>1</sup>
Mini ECOi with air out 30°C			U-4LE1E5/8 <sup>1</sup>	U-4LE1E5/8 <sup>1</sup>	U-4LE1E5/8 <sup>1</sup>	U-5LE1E5/8 <sup>1</sup>	U-4LE1E5/8 <sup>1</sup>	U-4LE1E5/8 <sup>1</sup>
ECOi with air out 40°C			All models	All models	All models	All models without 8HP	All models	All models
ECOi with air out 30°C or 35°C			All models	All models	All models	All models	All models	All models
ECO G all temperatures			All models	All models	All models	All models	All models	All models

All combinations under rated conditions: Heating Outdoor +7°C DB/+6°C WB Indoor +20°C DB. In case of lower outdoor temperatures a higher capacity outdoor unit model may be necessary. 1) Or bigger size. 2) Rated Conditions Cooling Outdoor +35°C DB Indoor +27°C DB/+19°C WB, Discharge temperature <sup>3</sup> 16°C.



## ENERGY RECOVERY VENTILATION

### Energy efficiency and ecology

Energy consumption is dramatically reduced by using a counter-flow heat-exchange element. Air conditioning load is reduced by approximately 20%, resulting in significant energy savings.

### Comparison of former and current elements

With the cross-flow element, air moves in a straight line across the element; with the counter-flow element, air flows through the element for a longer time (longer distance), so the heat-exchange effect remains unchanged even if the element is made thinner.

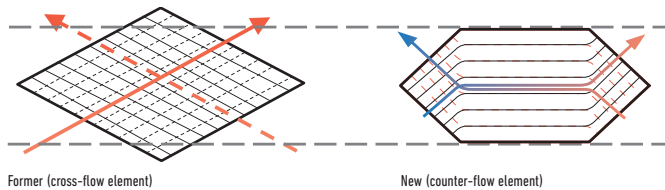

### Heat exchange ventilation and normal ventilation

Energy-saving ventilation can be achieved through the proper use of heat-exchange ventilation and normal ventilation.

#### Heat exchange ventilation.

When a room is cooled or heated, the exhausted cooling / heating energy is recovered by heat-exchange ventilation.

#### Normal ventilation.

This is used in the spring and autumn, when rooms are not cooled or heated, that is, when there is little difference between the indoor and outdoor air conditions. In addition, at night during the hot season, when the outside air temperature drops the outside air is drawn inside without heat exchange, alleviating the load on the air conditioning equipment. The heat exchanger is made up of a membrane manufactured from a special material covered in resin for optimal heat transmission. The nylon/polyester fibre filter offers high dust retention capacity. We have also redesigned the air ducts to obtain a long-lasting heat exchange system which does not need periodic cleaning.

### Heat exchanger

With the cross-flow element, air moves in a straight line across the element. With the counter-flow element, airflows through the element for a longer time (longer distance), so the heat-exchange effect remains unchanged even if the element is made thinner.



### More comfort

#### Quiet operation

Low noise operation results in noticeably quieter units. All models with capacities below 500m<sup>3</sup>/h run at noise levels below 32dB (High setting) and even our largest 1.000m<sup>3</sup>/h-capacity model runs at only 37,5dB (High setting).

### Long service life of heat-exchange element

We used a nonwoven cloth filter with a high dust collection efficiency and redesigned the air flow passages to achieve a durable heat-exchange element that requires no periodic cleaning.

Changes in airflow resistance based on number of years in service.

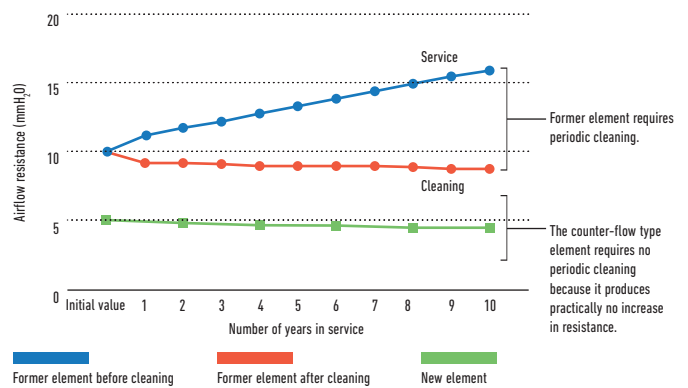

### Easy installation and maintenance

#### Slim shape and easier installation.

Counter-flow heat exchange element used for reduced noise and slimmer, more compact body shape.

270mm Height: FY-250ZDY8R // FY-350ZDY8R // FY-500ZDY8R

388mm Height: FY-800ZDY8R // FY-01KZDY8R

#### Reverse mountable direct air supply / exhaust system.

Adoption of straight air supply / exhaust system: Duct design is simplified because the air supply / exhaust ducts are straight.

Since each unit can be mounted in reverse position, only one inspection hole is needed for two units: Two units can share one inspection hole so duct work is easier and more flexible.

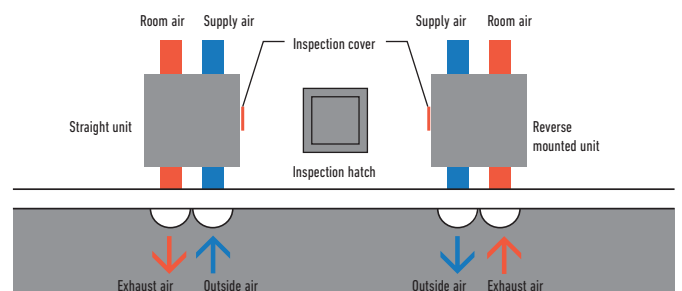

Suppresses indoor temperature changes while providing fresh air. Recovers up to 77% of the heat in the outgoing air, for an ecological and energy efficient building.

## Features

### Energy efficiency and ecology.

- Up to 20% energy saving in the installation
- Recovers up to 77% of the heat in the outgoing air

### Comfort.

- Cleaning reduced due to the revolutionary structure (every 6 months)
- Ideal for indoor spaces without windows

### Easy installation and maintenance.

- 6 models for easier selection
- Reduced system height (270mm and 388mm)
- Side opening for cleaning (inspection of filter, motor and other parts)
- Installation can be reversed to share an inspection opening between 2 machines
- Easy connection to the air conditioning unit (without additional elements)
- Installation in false ceilings
- Units operate at 220 - 240V
- High static pressure for easier installation

## Technical focus

- High energy saving, up to 20%
- Counter Cross Flow technology for better efficiency
- Long life element core
- Easy installation and 20% less thickness
- Easy connection to air conditioning units
- Silent units

## Balanced ventilation

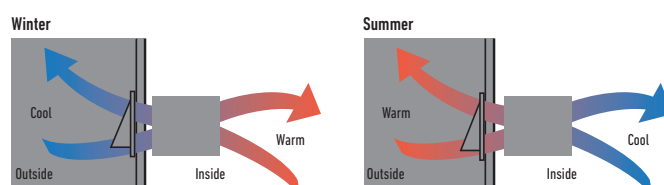

## A new intuitive & stylish control

- Included as a standard control
- Compact and flat panel
- Filter cleaning support
  - Signal alert for clearing
  - Filter usage condition by 1/2/3/4 months
- Size (W x H x D) 116 x 120 x 40mm



Rated flow rate	250m <sup>3</sup> /h			350m <sup>3</sup> /h			500m <sup>3</sup> /h			800m <sup>3</sup> /h			1000m <sup>3</sup> /h			
Models	FY-250ZDY8R			FY-350ZDY8R			FY-500ZDY8R			FY-800ZDY8R			FY-01KZDY8R			
																
	E-High	High	Low	E-High	High	Low	E-High	High	Low	E-High	High	Low	E-High	High	Low	
Power source	220V / 240V / 50Hz			220V / 240V / 50Hz			220V / 240V / 50Hz			220V / 240V / 50Hz			220V / 240V / 50Hz			
<b>Heat exchange ventilation</b>	<b>E-High</b>	<b>High</b>	<b>Low</b>	<b>E-High</b>	<b>High</b>	<b>Low</b>	<b>E-High</b>	<b>High</b>	<b>Low</b>	<b>E-High</b>	<b>High</b>	<b>Low</b>	<b>E-High</b>	<b>High</b>	<b>Low</b>	
Input power	112,00 / 128,00	108,00 / 123,00	87,00 / 96,00	182,00 / 190,00	178,00 / 185,00	175,00 / 168,00	263,00 / 289,00	204,00 / 225,00	165,00 / 185,00	387,00 / 418,00	360,00 / 378,00	293,00 / 295,00	437,00 / 464,00	416,00 / 432,00	301,00 / 311,00	
Air volume	250	250	190	350	350	240	500	500	440	800	800	630	1000	1000	700	
External static pressure	105	95	45	140	60	45	120	60	35	140	110	55	105	80	75	
Sound power	30,00 / 31,50	29,50 / 30,50	23,50 / 26,50	32,50 / 33,00	30,50 / 31,00	22,50 / 25,50	36,50 / 37,50	34,50 / 35,50	31,00 / 32,50	37,00 / 37,50	36,50 / 37,00	33,50 / 34,50	37,50 / 38,50	37,00 / 37,50	33,50 / 34,50	
Temperature exchange efficiency	75	75	77	75	75	78	75	75	76	75	75	76	75	75	79	
<b>Normal ventilation</b>	<b>E-High</b>	<b>High</b>	<b>Low</b>	<b>E-High</b>	<b>High</b>	<b>Low</b>	<b>E-High</b>	<b>High</b>	<b>Low</b>	<b>E-High</b>	<b>High</b>	<b>Low</b>	<b>E-High</b>	<b>High</b>	<b>Low</b>	
Input power	112,00 / 128,00	108,00 / 123,00	87,00 / 96,00	182,00 / 190,00	178,00 / 185,00	175,00 / 168,00	263,00 / 289,00	204,00 / 225,00	165,00 / 185,00	387,00 / 418,00	360,00 / 378,00	293,00 / 295,00	437,00 / 464,00	416,00 / 432,00	301,00 / 311,00	
Air volume	250	250	190	350	350	240	500	500	440	800	800	630	1000	1000	700	
External static pressure	105	95	45	140	60	45	120	60	35	140	110	55	105	80	75	
Sound power	30,00 / 31,50	29,50 / 30,50	23,50 / 26,50	32,50 / 33,00	30,50 / 31,00	22,50 / 25,50	37,50 / 38,50	37,00 / 38,00	31,00 / 32,50	37,00 / 37,50	36,50 / 37,00	33,50 / 34,50	39,50 / 40,50	39,00 / 39,50	35,50 / 36,50	
Temperature exchange efficiency	—	—	—	—	—	—	—	—	—	—	—	—	—	—	—	
Dimension	HxWxD	mm 270x882x599			317x1050x804			317x1090x904			388x1322x884			388x1322x1134		
Net weight	kg	29			49			57			71			83		

This noise of the product is the value which was measured at the acoustic room. Actually, in the established condition, that undergo influence by the echoing of the room and so that become bigger than the display numerical value. The input, the current and the exchange efficiency are values at the time of the mentioned air volume. The noise level shall be measured 1,5m below the centre of the unit. The temperature exchange efficiency averages that of when cooling and when heating.

## HEAT RECOVERY WITH DX COIL

Panasonic launches an heat recovery solution for greater energy efficiency.

Panasonic's heat recovery solution performs well in extreme weather conditions and can achieve up to 77% efficiency (63% in enthalpy efficiency).

The counter-flow heat exchanger reduces the air conditioning load, enabling customers – typically owners of hotels, restaurants and other large commercial buildings – to reduce their energy consumption and save on the cost of maintaining comfortable room temperatures.

### Energy efficiency

As the latest example of Panasonic's continued commitment to developing unbeatable, energy-efficient air conditioning technologies for commercial applications, the company has introduced a heat recovery device.

The unit features a DX Coil designed to recover up to 77% of the heat from outgoing air, and a air purifying system which helps to improve air quality. In even the most demanding commercial applications, business owners will benefit from the unit's ability to by-pass the heat exchange process when the outside air temperature is cool enough for fresh air to be drawn directly inside (free cooling).

This alleviates the load on the air conditioning equipment and consequently reduces energy bills.



### Supply section complete

The supply section comes complete with the DX coil (using R410A refrigerant) – fitted with a solenoid control valve, freon filter, contact temperature sensors on the liquid and gas line, and NTC sensors on the upstream and downstream airflows. The built-in electric box is equipped with a PCB to control the internal fan speed and to interconnect the outdoor and indoor units, and the ducts are connected by circular plastic collars.

### Characteristic curves

The following curves show the unit external static pressure at maximum fan speed for each model.

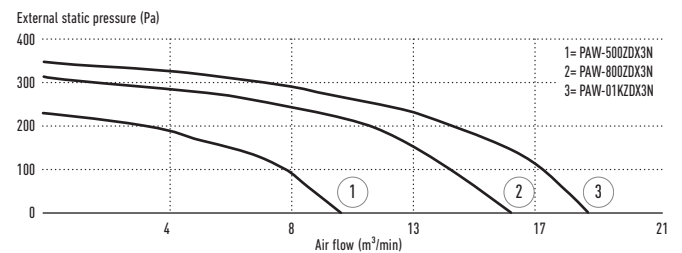

### Balanced Ventilation

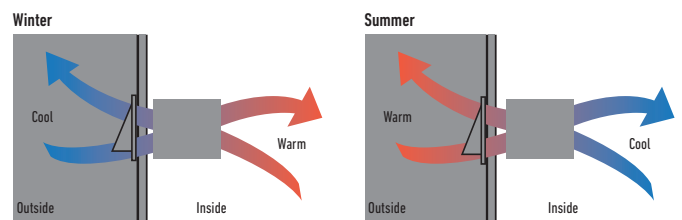



ECOi and ECO G Systems Ventilation units

**Interconnection**

This ventilation unit is connected to an ECOi indoor unit (3,0kW, 4,0kW or 4,5kW) and can be controlled by the easy-to-use ECOi remote controller CZ-RTC5B.

This capability makes the system an excellent choice for hotels, offices (large and small), educational settings and other buildings requiring different temperatures in multiple rooms. The system also integrates easily with building management systems.

**Technical focus**

- Motorised heat recovery by-pass device automatically controlled by unit control to use fresh air free-cooling when convenient

**General characteristics**

- Galvanized steel self-supporting panels, internally and externally insulated
- Counterflow air-to-air heat recovery device, made of sheets of special paper with special sealing to keep airflows separate and only permeable to water vapour. Total heat exchange with temperature efficiency up to 70% and enthalpy efficiency up to 67%, also at high level during summer season

- G4 efficiency class filters with synthetic cleanable media, both on fresh air and return air intake
- Removable side panel to access filters and heat recovery in the event of scheduled maintenance
- Low consumption, high efficiency & low noise direct driven fans
- Supply section complete with DX Coil (R410A) fitted with solenoid control valve, freon filter, contact temperature sensors on liquid and gas line, NTC sensors upstream and downstream airflow
- Built-in electric box equipped with PCB to control internal fan speed and to interconnect outdoor/indoor units
- Duct connection by circular plastic collars
- CZ-RTC5B Timer remote controller (option)

**Interconnection to outdoor/indoor units**

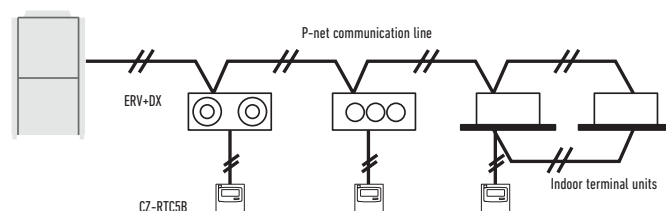

Model	PAW-500ZDX3N		PAW-800ZDX3N		PAW-01KZDX3N			
Power source	Voltage	V	230	230	230	230		
	Phase		Single Phase	Single Phase	Single Phase	Single Phase		
	Frequency	Hz	50	50	50	50		
Air volume		m <sup>3</sup> /min	8,33	13,33	16,66	16,66		
External static pressure <sup>1</sup>		Pa	90	120	115	115		
Maximum current	Total full load	A	0,6	1,4	2,1	2,1		
Input power		W	150	320	390	390		
Sound pressure <sup>2</sup>		dB(A)	39	42	43	43		
Piping connections	Liquid pipe	Inch (mm)	1/4 (6,35)	1/4 (6,35)	1/4 (6,35)	1/4 (6,35)		
	Gas pipe	Inch (mm)	1/2 (12,70)	1/2 (12,70)	1/2 (12,70)	1/2 (12,70)		
<b>Heat recovery</b>			<b>Cooling</b>	<b>Heating</b>	<b>Cooling</b>	<b>Heating</b>		
Temperature efficiency	%		76	76	76	76		
Enthalpy efficiency	%		63	67	63	62		
Saved power summer mode or winter mode*	kW		1,70	4,30 (4,80)	2,50	6,50 (7,30)	3,20	8,20 (9,00)
<b>DX Coil</b>								
Total / Sensible capacity	kW		3,00 / 2,10	2,50 / 2,70	5,10 / 3,50	4,40 / 4,80	5,80 / 4,10	5,20 / 6,70
Off temperature	°C		15,9	30,1 (29,2)	17,9	27,5 (26,5)	18,6	26,3 (25,3)
Off relative humidity	%		90	16 (15)	90	14 (13)	89	15 (14)

Nominal summer conditions: Outside air: 32°C DB, RH 50%. Ambient air: 26°C DB, RH 50%. Nominal winter conditions: Outside air: -5°C DB, RH 80%. Ambient air: 20°C DB, RH 50%. Cooling mode air inlet condition: 28.5°C DB, RH 50%; evaporating temperature 7°C. Heating mode air inlet condition: 13°C DB, RH 40% (11°C DB, RH 45%); condensating temperature 40°C. DB: Dry Bulb; RH: Relative Humidity.

1) Referred to the nominal air flow after filter and plate heat exchanger. 2) Sound pressure level calculated at 1m far from: ducted supply exhaust air ducted return - first air intake / service side, at normal condition. \* Tentative data.



ECONAVI and INTERNET CONTROL: Optional.

# DIMENSIONS AND TUBE SIZES OF BRANCHES AND HEADERS FOR ECOi 2-PIPE SYSTEMS

## Optional Distribution Joint Kits

See the installation instructions packaged with the distribution joint kit for the installation procedure.

Model name	Cooling capacity after distribution	Remarks
1. CZ-P680PH2BM	68,0kW or less	For outdoor unit
2. CZ-P1350PH2BM	From 68,0kW to 168,0kW	For outdoor unit
3. CZ-P224BK2BM	22,4kW or less	For indoor unit
4. CZ-P680BK2BM	From 22,4kW to 68,0kW	For indoor unit
5. CZ-P1350BK2BM	From 68,0kW to 168,0kW	For indoor unit

## Tube size (with thermal insulation)

1. CZ-P680PH2BM: For outdoor unit side (Capacity after distribution joint is 68,0kW or less).

Gas tubing

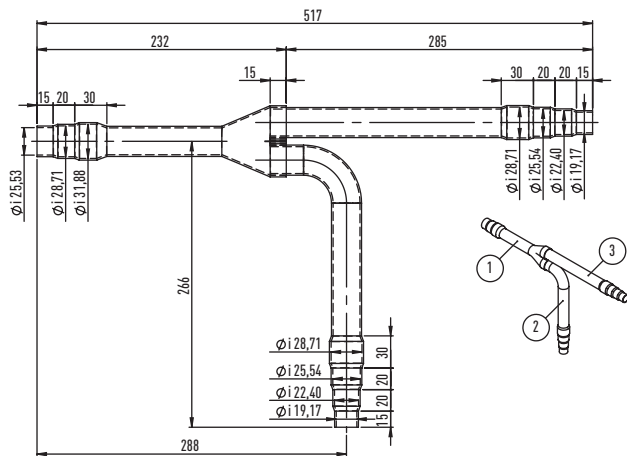

Liquid tubing

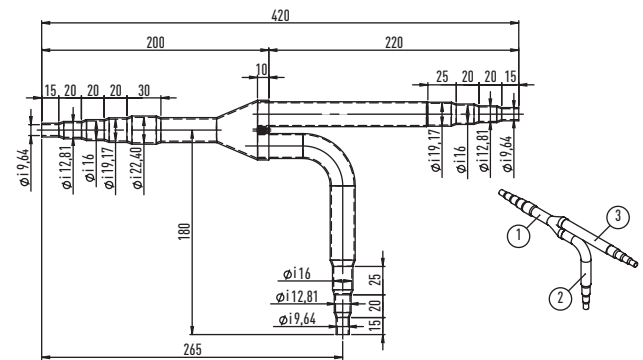

Unit: mm

2. CZ-P1350PH2BM: For outdoor unit side (Capacity after distribution joint is greater than 68,0kW and no more than 168,0kW).

Gas tubing

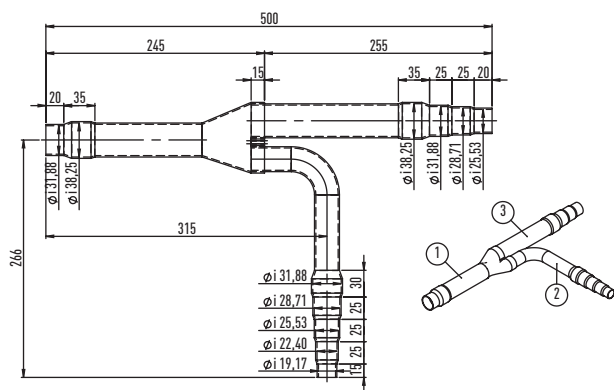

Liquid tubing

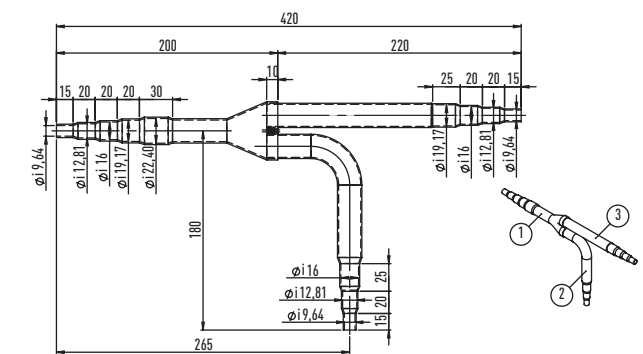

Unit: mm

3. CZ-P224BK2BM: For indoor unit side (Capacity after distribution joint is 22,4kW or less).

Gas tubing

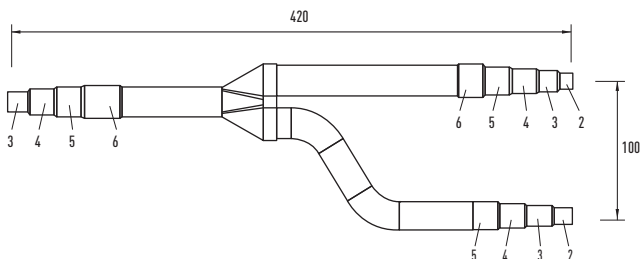

Liquid tubing

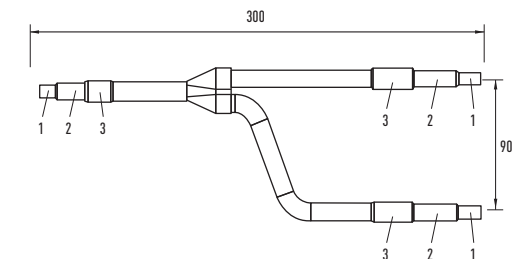

Unit: mm

**4. CZ-P680BK2BM:** For indoor unit side (Capacity after distribution joint is greater than 22,4kW and no more than 68,0kW).

Gas tubing

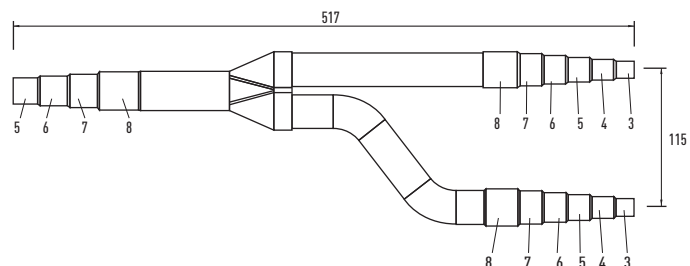

Liquid tubing

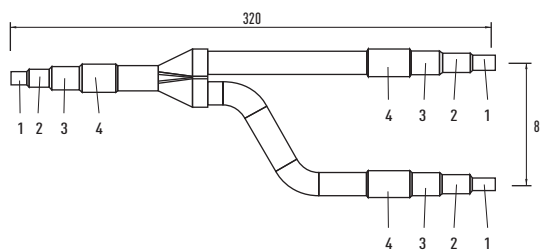

Unit: mm

**5. CZ-P1350BK2BM:** For indoor unit side (Capacity after distribution joint is greater than 68,0kW and no more than 168,0kW).

Gas tubing

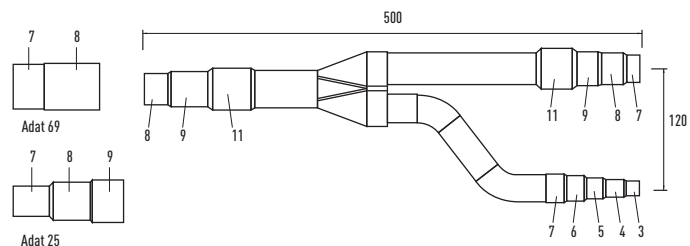

Liquid tubing

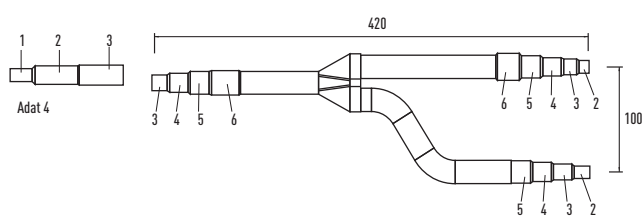

Unit: mm

Diameters		Diameters		Diameters	
1	6,35 mm 1/4"	6	22,40 mm 7/8"	11	38,10 mm 1 1/2"
2	9,52 mm 3/8"	7	25,40 mm 1"	12	41,28 mm 1 5/8"
3	12,70 mm 1/2"	8	28,57 mm 1 1/8"	13	44,45 mm 1 3/4"
4	15,88 mm 5/8"	9	31,75 mm 1 1/4"	14	50,80 mm 2"
5	19,05 mm 3/4"	10	34,92 mm 1 3/8"		

**Header pipe set for ECOi 2-Pipe system**

**CZ-P4HP4C2BM:** Header pipe models for 2-Pipe systems.

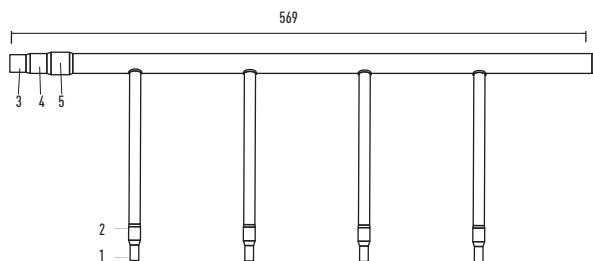
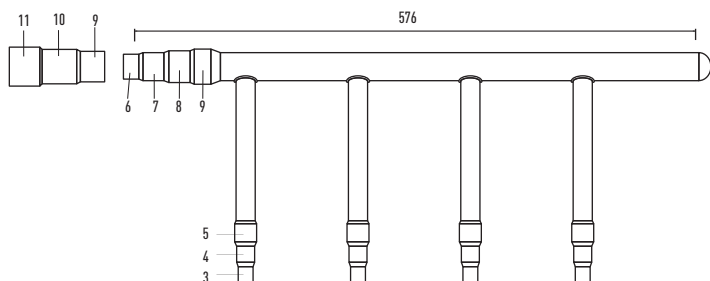

Diameters		Diameters		Diameters	
1	6,35 mm 1/4"	5	19,05 mm 3/4"	9	31,75 mm 1 1/4"
2	9,52 mm 3/8"	6	22,40 mm 7/8"	10	34,92 mm 1 3/8"
3	12,70 mm 1/2"	7	25,40 mm 1"	11	38,10 mm 1 1/2"
4	15,88 mm 5/8"	8	28,57 mm 1 1/8"		

# BRANCHES AND HEADERS FOR 3-PIPE ECOi AND MINI ECOi

## Optional distribution joint Kits for 3-Pipe ECOi 6N Systems (MF2)

See the installation instructions packaged with the distribution joint kit for the installation procedure.

\* In case the total capacity of indoor units connected after distribution exceeds the total capacity of the outdoor units, select the distribution piping size for the total capacity of the outdoor units.

Model name	Cooling capacity after distribution	Remarks
1. CZ-P680PJ2BM	68,0kW or less	For outdoor unit
2. CZ-P1350PJ2BM	Greater than 68,0kW and no more than 135,0kW	For outdoor unit
3. CZ-P224BH2BM	22,4kW or less	For indoor unit
4. CZ-P680BH2BM	Greater than 22,4kW and no more than 68,0kW	For indoor unit
5. CZ-P1350BH2BM	Greater than 68,0kW and no more than 135,0kW	For indoor unit

## Piping size for 3-Pipe ECOi 6N Systems (MF2)

### 1. CZ-P680PJ2BM

For outdoor unit side (capacity after distribution joint is 68,0kW or less).

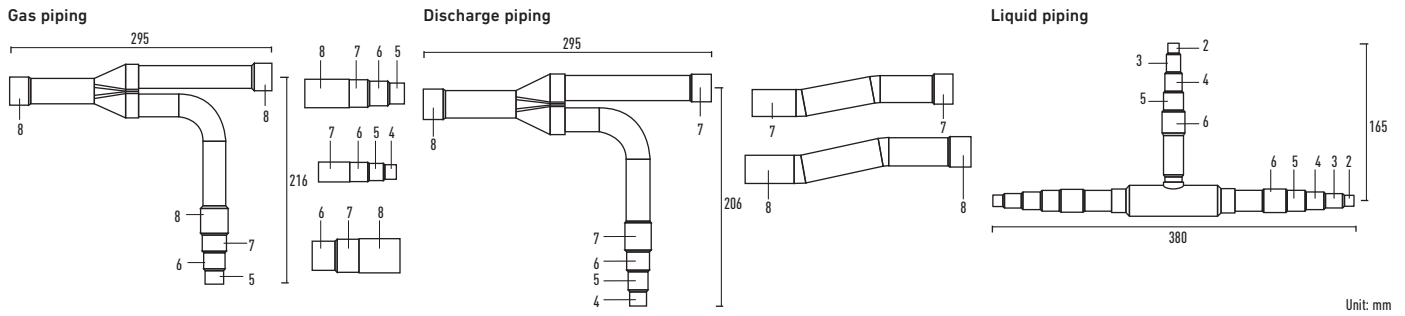

### 2. CZ-P1350PJ2BM

For outdoor unit side (capacity after distribution joint is greater than 68,0kW and no more than 135,0kW).

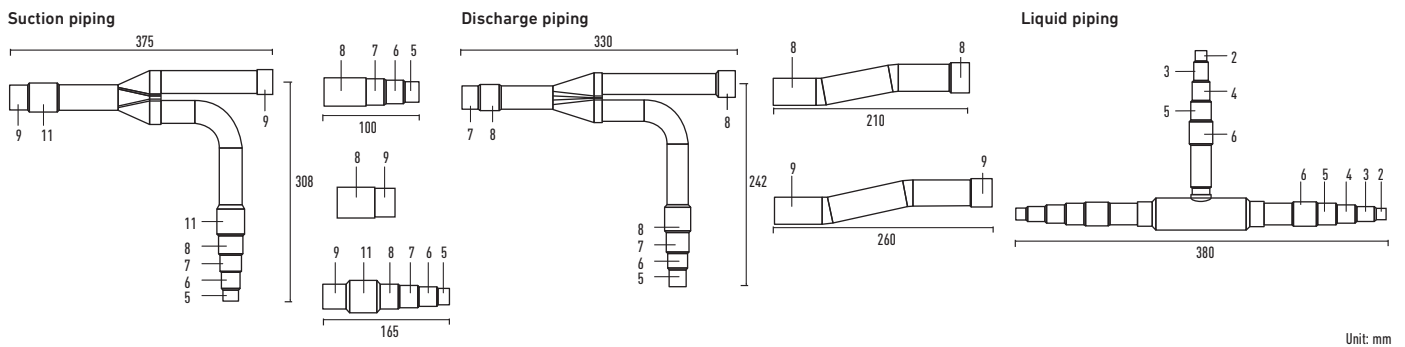

### 3. CZ-P224BH2BM

For indoor unit side (capacity after distribution joint is 22,4kW or less).

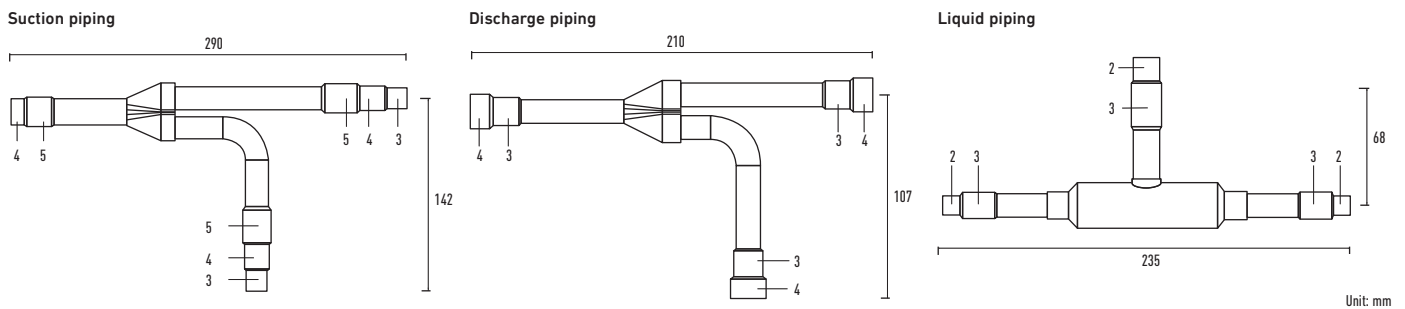

## Size of connection point on each part (shown are inside diameters of piping)

Size	Part 1	Part 2	Part 3	Part 4	Part 5	Part 6	Part 7	Part 8	Part 9	Part 10	Part 11	Part 12	Part 13	Part 14
Dimension	mm	6,35	9,52	12,70	15,88	19,05	22,40	25,40	28,57	31,75	34,92	38,10	41,28	44,45
	Inches	1/4	3/8	1/2	5/8	3/4	7/8	1	1 1/8	1 1/4	13/8	11/2	15/8	13/4

### 4. CZ-P680BH2BM

For indoor unit side (capacity after distribution joint is greater than 22,4kW and no more than 68,0kW).

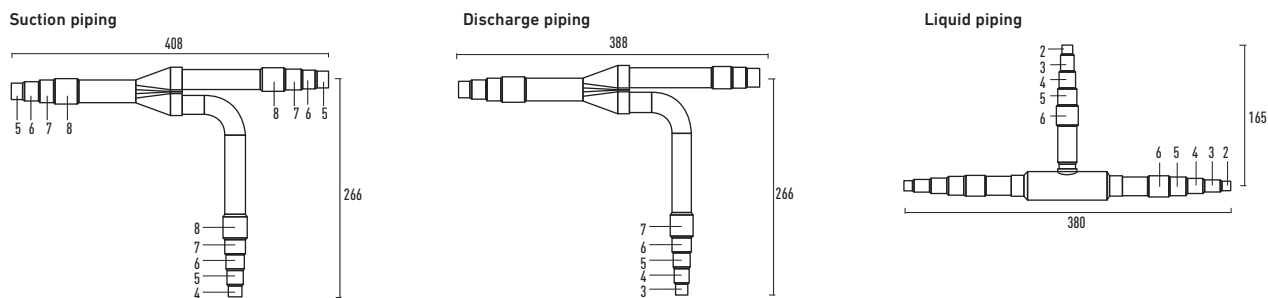

Unit: mm

### 5. CZ-P1350BH2BM

For indoor unit side (capacity after distribution joint is greater than 68,0kW and no more than 135,0kW).

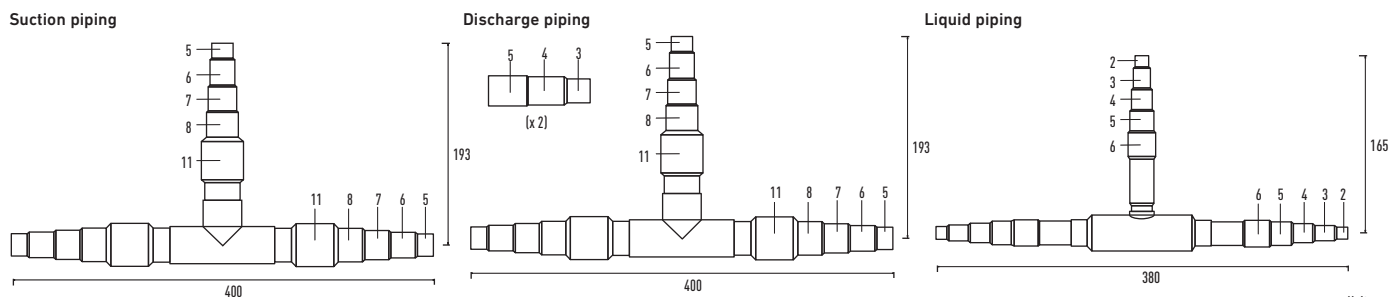

Unit: mm

## Header pipe set for 3-Pipe ECOi 6N Systems (MF2)

### CZ-P4HP3C2BM

Header pipe model for 3-Pipe systems.

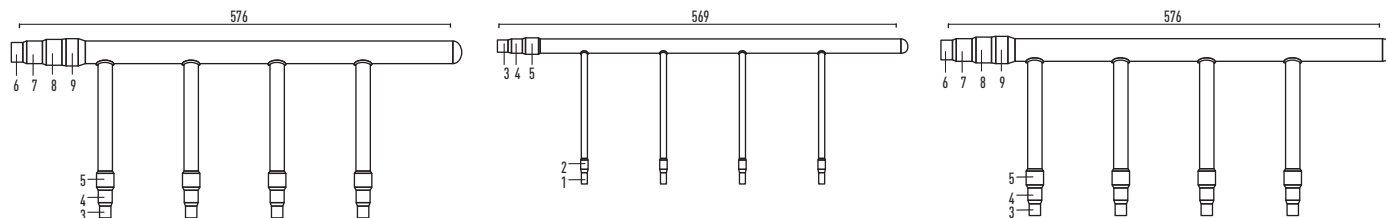

Size of connection point on each part (shown are inside diameters of piping)

Size	Part 1	Part 2	Part 3	Part 4	Part 5	Part 6	Part 7	Part 8	Part 9	Part 10	Part 11	
Dimension	mm	6,35	9,52	12,70	15,88	19,05	22,40	25,40	28,57	31,75	34,92	38,10
	Inches	1/4	3/8	1/2	5/8	3/4	7/8	1	1 1/8	1 1/4	13/8	11/2

## Distribution joint Kits for Mini ECOi LE1 Series

### CZ-P160BK2

For indoor unit (capacity after distribution joint is 22,4kW or less).

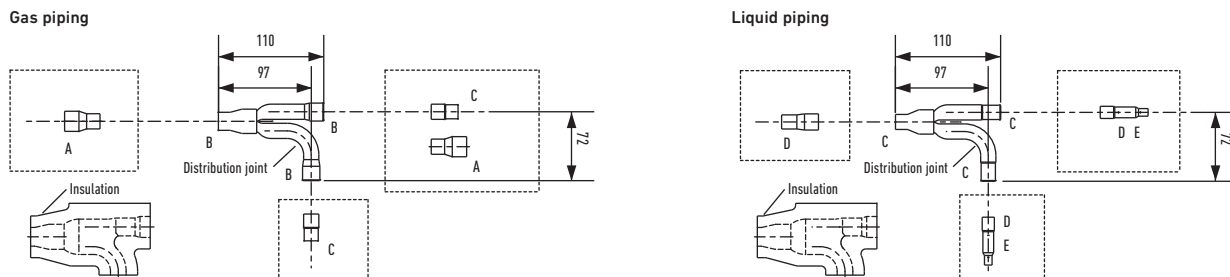

Unit: mm

Size of connection point on each part (shown are inside diameters of piping)

Size	Part A	Part B	Part C	Part D	Part E	
Dimension	mm	19,05	15,88	12,70	9,52	6,35
	Inches	3/4	5/8	1/2	3/8	1/4

# ACCESSORIES & CONTROL

## Distribution Joint Kits

### CZ-P680PJ2

2-Pipe ME2 Series Distribution Joint Kit for outdoor unit (68,0kW or less).

### CZ-P1350PJ2

2-Pipe ME2 Series Distribution Joint Kit for outdoor unit (more than 68,0kW).

### CZ-P160BK2

2-Pipe ME2 Series and Mini ECOi LE1 Series Distribution Joint Kit for indoor unit (22,4kW or less\*).

### CZ-P680BK2

2-Pipe ME2 Series Distribution Joint Kit for indoor unit (68,0kW or less\*).

### CZ-P1350BK2

2-Pipe ME2 Series Distribution Joint Kit for indoor unit (more than 68,0kW\*).

### CZ-P680PJ2BM

3-Pipe MF2 6N Series Distribution Joint Kit for outdoor unit (68,0kW or less).

### CZ-P1350PJ2BM

3-Pipe MF2 6N Series Distribution Joint Kit for outdoor unit (greater than 68,0kW and no more than 135,0kW).

### CZ-P224BH2BM

3-Pipe MF2 6N Series Distribution Joint Kit for indoor unit (22,4kW or less).

### CZ-P680BH2BM

3-Pipe MF2 6N Series Distribution Joint Kit for indoor unit (greater than 22,4kW and no more than 68,0kW).

### CZ-P1350BH2BM

3-Pipe MF2 6N Series Distribution Joint Kit for indoor unit (greater than 68,0kW and no more than 135,0kW).

### CZ-P4HP3C2BM

3-Pipe MF2 6N Series Header Pipe.

\* In case the total capacity of indoor units connected after distribution exceeds the total capacity of the outdoor units, select the distribution piping size for the total capacity of the outdoor units.

## Heat Recovery Box

### KIT-P56HR3

Box recovery kit up to 5,6kW (CZ-P56HR3 + CZ-CAPE2).



### KIT-P160HR3

Box recovery kit from 5,6kW (CZ-P160HR3 + CZ-CAPE2).

### CZ-P56HR3

Heat recovery box up to 5,6kW.

### CZ-CAPE2

Heat recovery PCB.

### CZ-P160HR3

Solenoid valve kit up to 10,6kW.



### CZ-P456HR3

4 ports 3 pipe box up to 5,6kW.

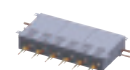

### CZ-P4160HR3

4 ports 3 pipe box up to 16,0kW.

### CZ-P656HR3

6 ports 3 pipe box up to 5,6kW.

### CZ-P856HR3

8 ports 3 pipe box up to 5,6kW.

## Individual Controls



### CZ-RTC5B

Design wired remote controller with Econavi button and datanavi.



### CZ-RTC2

Standard wired remote controller for Floor Standing (MP1).



### CZ-RWSU3

Wireless remote control for 90x90 Cassette PU2.



### CZ-RWSL2N

Wireless remote controller for 2 Way Cassette.



### CZ-RWSK2

Wireless remote control for Wall mounted (and CZ-RWSC3).



### CZ-RWSC3

Wireless receiver kit (need CZ-RWSK2 separately).



### CZ-RWSD2

Wireless remote controller for 1 Way Cassette.



### CZ-RWST3N

Wireless remote control for Ceiling.



### CZ-CSRC3

Temperature Remote sensor.



### CZ-RE2C2

Simplified remote control.

## Controller for Hotels with Dry Contacts



### PAW-RE2C3-WH

Stand-Alone with I/O White frame.

### PAW-RE2C3-MOD-WH

Modbus RS-485 with I/O White frame.

### PAW-RE2C3-MOD-WH

Modbus RS-485 with I/O White frame.

### PAW-RE2C3-GR

Stand-Alone with I/O Grey Frame.

### PAW-RE2C3-MOD-GR

Modbus RS-485 with I/O Grey frame.

### PAW-RE2C3-MOD-GR

Modbus RS-485 with I/O Grey frame.

## Controller for Hotels with Dry Contacts



### CZ-64ESMC3

System Controller with Schedule timer. Operation with various function from center station.



### CZ-ANC3

Central On/Off controller, up to 16 groups, 64 indoor units.



### CZ-256ESMC3

Simplified load distribution ratio (LDR) for each tenant. Intelligent Controller (Touch screen panel).

## Centralised Controls. BMS System. PC Base



### CZ-CSWKC2

PAIMS Basic software.



### CZ-CSWAC2

PAIMS Consumption calculation control.

### CZ-CSWGC2

PAIMS - Layout display.



### CZ-CAPDC2

Serial parallel device controlling outdoor units, up to 4 units.



### CZ-CAPC3

Adaptor for On/off control of external devices.



### CZ-CAPBC2

Mini series parallel device controlling indoor units, maximum 1 group and 8 indoor unit.



### CZ-CFUNC2

Communication Adaptor. Up to 128 groups. Controls 128 units.

### CZ-CFUNC2

Communication adaptor.

### CZ-CSWBC2

PAIMS - BACnet interface.

### CZ-CSWWC2

PAIMS - Web application.

## Centralised Controls. Connection with 3rd Party Controller

### Panasonic AC Smart Cloud



**CZ-CFUSCC1**  
Panasonic AC Smart Cloud. Cloud internet control. Up to 128 groups. Controls 128 units.

### VRF Smart Connectivity



**SER8150R0B1194**  
Remote Controller  
Panasonic Net Con, RH, No PIR, R1/R2.

**SER8150R5B1194**  
Remote Controller  
Panasonic Net Con, RH, PIR, R1/R2.

**VCM8000V5094P**  
Panasonic R1R2 to Zigbee adaptor box No Brand.

**VCM8000V5094G**  
(For Wave1) Wireless Zigbee Pro / Green Com card (required in case Wave1 wired product need to do MPM connection).



**SED-WMS-P-5045**  
Wireless Sensors Wall motion sensor.



**SED-WDS-P-5045**  
Wireless Sensors Door/window contact.



**SED-CMS-P-5045**  
Wireless Sensors Ceiling motion sensor.



**SED-CO2-G-5045**  
CO<sub>2</sub> sensor.



### Accessories Cables



**CZ-T10**  
Cable for all the T10 functions.



**PAW-FDC**  
Cable to operate external EC fan.



**PAW-OCT**  
Cable for all option monitoring signals.

**PAW-EXCT**  
Cable with force Thermo OFF/leakage Detection.



**PAW-T10**  
All T10 functions.



**PAW-PACR3**  
Redundancy of 2 or 3 systems; for PACi and ECOi.

**PAW-ECF**  
PCB for fan speed control of external EC Fan.

### Accessories Interfaces



**PAW-RC2-KNX-1i**  
KNX Interface.



**PAW-AC-BAC-1**  
BACnet Interface for 1 unit.



**PAW-RC2-MBS-1**  
Modbus Interface.



**PAW-RC2-MBS-4**  
Modbus interface to control 4 indoor/groups.



**PAW-MBS-TCP2RTU**  
Modbus RTU Slave devices.



**PAW-RC2-ENO-1i**  
EnOcean Interface.



**PA-RC2-WIFI-1**  
Interface for Inteshome for PACi & ECOi.

**PAW-AC-KNX-64**  
KNX Interface for 64 indoors.

**PAW-AC-BAC-64**  
BACnet Interface for 64 indoor units.

**PAW-AC-MBS-64**  
Modbus Interface for 64 indoors.

**PAW-AC-MBS-128**  
Modbus Interface for 128 indoors.

**PAW-AC-KNX-128**  
KNX Interface for 128 indoors.

**PAW-AC-BAC-128**  
BACnet Interface for 128 indoor units.

**PAW-TM-MBS-RTU-64**  
Modbus Interface for 64 indoors.

**PAW-TM-MBS-TCP-128**  
Modbus Interface for 128 indoors.



**CZ-CAPRA1**  
Domestic with CZ-CNT port integration to PACi and ECOi.



**CZ-CLNC2**  
Lonworks® Interface controls up to 16 groups and 64 indoor units.

### Pump Down System



**PAW-PUDME1A-3**  
ECOi 2-Pipe Pump down for 3 outdoor units system.

**PAW-PUDMF2A-1**  
ECOi 3-Pipe Pump down for 1 outdoor unit system.

**PAW-PUDMF2A-2**  
ECOi 3-Pipe Pump down for 2 outdoor units system.

**PAW-PUDMF2A-3**  
ECOi 3-Pipe Pump down for 3 outdoor units system.

**PAW-PUDME1A-1**  
ECOi 2-Pipe Pump down for 1 outdoor unit system.

**PAW-PUDME1A-2**  
ECOi 2-Pipe Pump down for 2 outdoor units system.

**PAW-PUDME1A-1R**  
ECOi 2-Pipe Pump down for 1 outdoor unit system + Receiver Kit 30L.

**PAW-PUDME1A-2R**  
ECOi 2-Pipe Pump down for 2 outdoor units system + Receiver Kit 30L.

**PAW-PUDME1A-3R**  
ECOi 2-Pipe Pump down for 3 outdoor units system + Receiver Kit 30L.

**PAW-PUDMF2A-1R**  
ECOi 3-Pipe Pump down for 1 outdoor unit system + Receiver Kit 30L.

**PAW-PUDMF2A-2R**  
ECOi 3-Pipe Pump down for 2 outdoor units system + Receiver Kit 30L.

**PAW-PUDMF2A-3R**  
ECOi 3-Pipe Pump down for 3 outdoor units system + Receiver Kit 30L.

**PAW-PUDRK30L**  
Receiver Kit 30L.

### R-22 Replacement Kit

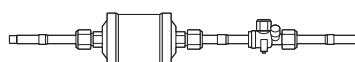

**CZ-SLK2**  
Replacement kit for R-22.

### Other Accessory



**CZ-CENSC1**  
Econavi energy savings sensor.

### Fan coil Controller



**PAW-FC-303TC**  
Fan coil control.

Due to the ongoing innovation of our products, the specifications of this catalogue are valid barring typographic errors, and may be subject to minor modifications by the manufacturer without prior warning in order to improve the product. The total or partial reproduction of this catalogue is prohibited without the express authorisation of Panasonic Marketing Europe GmbH.

# Panasonic®

To find out how Panasonic cares for you, log on to: [www.aircon.panasonic.eu](http://www.aircon.panasonic.eu)

Panasonic Marketing Europe GmbH  
South-East Europe Branch Office  
H-1117, Neumann János utca 1. Hungary, Budapest



Do not add or replace refrigerant other than the specified type. Manufacturer is not responsible for the damage and deterioration in safety due to usage of the other refrigerant.  
The outdoor units in this catalogue contains fluorinated greenhouse gases with a GWP higher than 150.

